

Modeling the horizontal movement of bulk material in the system “conveyor – rotary mixer”

*Vladimir Zaselskiy, Sergey Shved, Mariia Shepelenko**, and *Nataliia Suslo*

Kryvyi Rih Metallurgical Institute of the National Metallurgical Academy of Ukraine, 5 Stephana Tilhy Str., Kryvyi Rih, 50006, Ukraine

Abstract. In this work, we consider methods for analytical construction of the profile of rotor blades mixer, as well as mathematical modeling of their work on moving and mixing bulk material on a conveyor to increase process efficiency mixing raw materials and optimizing its operating costs. In addition to increasing the effectiveness of the mixing process and lower operating costs, the goal of implementation the proposed methods is the consciousness of production with the least possible errors that would meet modern technical requirements and be adapted to consumer tasks. In this regard, the aim of this work was to determine rational parameters and geometric characteristics of the profile of the rotor mixer blades contributing to improving the quality of mixing the metallurgical charge transported on a conveyor belt. To achieve the goal by modeling, which is a key method of the fourth concept industrial revolution, using the developed mathematical model analyzed the movement of a particle of material along a conveyor belt with its subsequent interaction with the blades of the working body of the rotary mixer.

1 Introduction

To obtain metals and alloys of the required chemical composition and mechanical strength, apply various types of necessary raw materials. Such mixed raw materials, before operations sintering and smelting are called charge materials. Recently, with a deterioration the raw material base of the metallurgical complex of Ukraine, much attention should be paid mixing and other type of equipment capable of existing technological schemes, to improve the quality of preparation of charge materials before sintering and smelting [1], [2]. Implementation the concept of the fourth digital revolution precisely at the mixing stage is promising solution, since such a process is one of the main in technological schemes metallurgical production. Analysis of the works [3], [6], [7] related to the development and improvement of various kinds of continuous mixers in the preparation of bulk materials for their further use shows that such equipment should meet current trends in the development of this kind of technology, namely for metallurgical processes, have high performance and at the same time - the degree of mixing of raw materials with negligible operational and capital costs. However, the improvement of the mixer, made by such a structural scheme, is constrained the lack of theoretical research aimed at studying the movement of material on the blade horizontal mixer installed directly above the conveyor the tape of the transported device. Therefore, the study of the movement of material with blades high-performance mixer, working in conjunction with a layer of conveying raw materials on conveyor belt

is an urgent and timely scientific task. In this paper, we consider methods for analytical construction of the profile of rotor blades mixer, as well as mathematical modeling of the movement of bulk material along them and conveyor belt, which allows, based on technological requirements, to determine the necessary rational equipment parameters that enhance mixing efficiency components of the metallurgical charge. In addition, the purpose of consideration and implementation of such methods is the creation of production with the least number of errors that would ensure the necessary product quality adapted to the needs of consumers.

One such mixer in a number technological schemes of metallurgical production can be used mixer continuous with elastic truss elements, the design of which It is rather well described in a number of works [8-12]. However, an improvement on the mixer, made according to such a constructive scheme, constrained by the lack of theoretical research studies the movement of material on the mixer blades horizontally directed action installed directly above conveyor belt transported devices.

Therefore, the study of motion material with high-performance vanes mixer working in conjunction with the layer conveying raw materials on a conveyor belt, is an urgent and timely task. In this paper, we consider the methods: analytical construction of the profile of the blades charge rotor mixer rotor materials in order to increase the term operating equipment for the existing technological scheme for the production of sinter and pellets; material movement on the shoulder blade horizontal mixer actions.

* Corresponding author: shepelm2011@gmail.com

1.1 Work related sources

The existing rotary mixer with elastic cable elements in [3] has a number of advantages in comparison with batch mixers. They are more effective and can be used in existing technologies without significant investment. However, in [5] a mathematical model was constructed that takes into account additional vibrations that allow the material to move in a state of suspension. This condition allows significantly reduce energy costs during subsequent work, such as mixing.

1.2 Our contribution

This article presents some improvements based on the proposed methodology in [5]. From taking into account additional vibrations, the problem arises of determining the profile of the rotor blades mixer and the interaction of particles of the material with its surface. This article suggested algorithm for constructing the analytical profile of the blade [3] and analysis of the movement of the particle material on its curved surface.

1.3 Work structure

The rest of the paper is organized as follows. Section 2.1 contains preliminary information used in this article that describes the characteristic and principle of operation rotary mixer with elastic elements. Section 2.2 provides a mathematical description. The interaction of the product particles on the surface of the rough profile of the blade when it rotational exit from the material array. Section 2.3 gives an analytical method for determining allowable sector of the process of particle slip. Finally, Section 3 concludes and presents direction for future research.

2 Background

2.1 Rotary mixer design

This type of mixer is shown in Figure 1, for clarity, a section of the front part is made rotary mixer. The principle of this mixer with its design features it is rather well described in a number of works [3], [4], [5]. However, not one of them contains an analysis. the movement of material on the mixer blades, which would have a better idea of him work, and, accordingly, use in those or other technological lines with preparation of metallurgical raw materials production.

Rotary mixer is installed directly to the conveyor belt frame. It consists of a welded frame *1*, sections *2*. In bearing support *3* of each section two rotors are installed. Rotor drive with flexible cable elements *4* carried out by electric motors *5* sousing V-belt transmission *6*. Composite side with V-belt drives *7* are given in blade rotor movement *8*. As sealing section applied lamellar rubber *9* and *10*. At the inlet and outlet of the mixer A sealing rubber curtain is installed on the end walls. Support and regulation the gap between the tape and the rotors is adjusting screws *11*. Side walls sections are closed by fences *12* and *13* in order to prevent injury from

rotating parts. Depending on the technology requirements, number of section scan increase or decrease [3].

The principle of operation of a rotary mixer with a flexible cable rotor next: loose material moving on a conveyor belt, enters the mixing zone (which located between the conveyor belt and working elements of the rotor), where it falls under the effect of complex force *4* in rotor with flexible cable elements each section *2* located first on the direction of movement of the conveyor belt and driven by an electric motor *5*. Rotating rotor *4* with its flexible elements that are staggered order for complete overlap of the zone mixing performs integrated impact on the material while loosening and stirring it. Having the ability to change lengths of flexible cable elements, as well as their diameter, can fit rotor with flexible elements for specific conditions technological process. Moving on the material is affected by the blade rotor *8*, which performs more than intensive mixing loosened material.

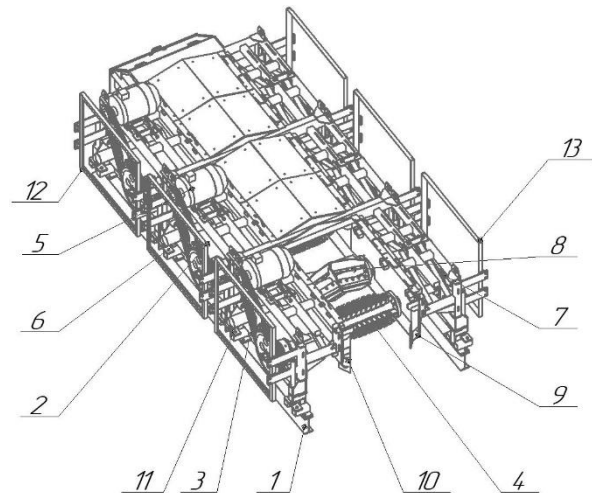

Fig. 1. Rotary mixer with flexible cable element in section [3].

Clearance between work items rotors *4*, *8* and conveyor belt supported thanks to the adjusting screws *11*. This the gap reduces wear on the tape conveyor belt from abrasive friction material on the tape, thereby increasing its life service. The disadvantage of the mixer in questions that he is not standalone and used with conveyor when transporting dry materials.

2.2 Bulk product behavior on rough profile surface blades during its rotational withdrawal from product array

Consider the motion of a material particle along rough surface of a rotating blade mixer.

We assume that when the blade leaves an array of bulk material that moves along the conveyor belt, she as a result of it excavation carries away some of it portion. Consider the possibility of the process release the scapula from the material, located on it, in the process of rotational rotor movements. We assume that slippage between conveyor belt and rotor blades missing. Then the conditional angular velocity of rotation of the rotor ω_r

with the blades is in kinematic correspondence with the linear speed of the conveyor belt V .

Let the material particle be on the surface of a rotating rough blade (Fig. 2), where h is the height of the layer of transported material on the conveyor belt. To study the movement particles, we introduce two coordinates of the system, as shown in Figure 3. Absolutely one fixed xOy associated with the horizon, and the second τMn movable (relative), associated with the tangent to the profile of the scapula. The tangent axis is inclined at an angle to the radius point position vector.

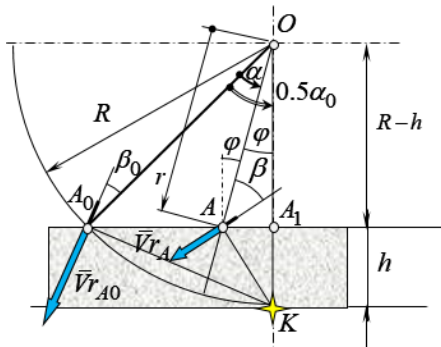

Fig. 2. Explanation of the interaction of the blade with the transported layer of material (shaping of the blades).

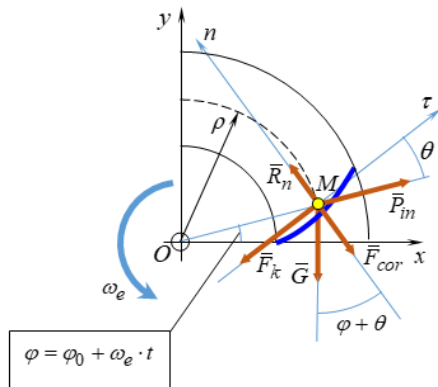

Fig. 3. System of forces applied to material point on the rotor blade making uniform rotation in vertical plane.

The plane of rotation of the blade is located vertically and therefore the action of force gravity per particle in the relative system reference will linearly depend on its angle rotation, from the angle of inclination of the tangent to her profile, as well as from time to time with focus. This dependence may be presented as follows:

$$\begin{cases} G_n = -mg \cdot \cos(\varphi + \theta) \\ G_\tau = -mg \cdot \sin(\varphi + \theta) \end{cases} \quad (1)$$

Note that with uniform rotation of the rotor its current rotation angle is easy to imagine as a function of time:

$$\varphi = \varphi_0 + \omega_e \cdot t \quad (2)$$

And the angle of inclination of the tangent is a function of the position of the point:

$$\theta = \left(\frac{dy_L}{dx_L} \right) \quad (3)$$

where $\frac{dy_L}{dx_L}$ is the derivative of the profile function of the blade, which, in accordance with the solution differential equation (based on Fig. 2, the condition for the formation of the blade profile is accepted in the diametrical plane of the rotor), we obtain the profile function of the blade

$$y(x) = x \cdot \frac{\sqrt{x^2 - (R-h)^2}}{2(R-h)} - \frac{R-h}{2} \cdot \ln \ln \left[\frac{x + \sqrt{x^2 - (R-h)^2}}{R-h} \right] \quad (4)$$

or as a result of which we obtain the following expression for determining the angle θ :

$$\frac{dy_L}{dx_L} = \frac{\sqrt{x^2 - (R-h)^2}}{R-h} \quad (5)$$

Considering that with this choice of reference systems $x=\rho$, we get:

$$\theta = \left(\frac{\sqrt{\rho^2 - (R-h)^2}}{R-h} \right) \quad (6)$$

In addition to gravity in the relative system reference to the particle act: inertia force in her portable movement $\overline{P_{in}}$; inertia force from Coriolis acceleration $\overline{F_{cor}}$ (acceleration vector Coriolis directed according to rule Zhukovsky); two forces from imposed bonds – $\overline{R_n}$ (unconditional one-way response kinematic connection) and $\overline{F_k}$ (reaction through Coulon friction).

The force of inertia in a figurative movement is a function of the relative position of the particle

$$|P_{in}| = m \cdot |a_{en}| = m\omega_e^2 \cdot \rho \quad (7)$$

The force of inertia from the action of Coriolis acceleration is a function of its relative speed, and modulo takes value

$$|F_{cor}| = 2m\omega_e \cdot \dot{\rho} \quad (8)$$

Resistance force to particle motion in neglected air.

Coulomb friction force of a particle with coefficient of sliding friction k about the surface of the blade depends on the pressing force, the value of which corresponds exactly support reactions $\overline{R_n}$ unconditional kinematic connection. The balance of power at relative particle equilibrium in according to the scheme of action of forces in normal to the surface of the scapula will take the form:

$$R_n - F_{cor} - G \cdot \cos \cos (\varphi + \theta) = 0 \quad (9)$$

From where we calculate the friction force modulus:

$$|F_k| = k \cdot F_{cor} + k \cdot G_n = k \cdot m \cdot 2\omega_e \cdot \dot{\rho} + k \cdot mg \cdot \cos \left[\omega_e t + \varphi_0 + \arctg \left(\frac{\sqrt{\rho^2 - (R-h)^2}}{R-h} \right) \right] \quad (10)$$

Based on the basic dynamics equation for relative motion of a material point in accordance with the direction of action of forces, shown in the diagram (Fig. 3), we have:

$$m \cdot \ddot{\rho} = P_{in} - F_k - mg \sin \times$$

$$\times \left[\omega_e t + \varphi_0 + \arctg \left(\frac{\sqrt{\rho^2 - (R-h)^2}}{R-h} \right) \right] \quad (11)$$

Or after substituting the input quantities:

$$\begin{aligned} m \cdot \ddot{\rho} &= m\omega_e^2 \cdot \rho - k \cdot m \cdot 2\omega_e \cdot \dot{\rho} - \\ &- kmg \cdot \cos \left[\omega_e t + \varphi_0 + \arctg \left(\frac{\sqrt{\rho^2 - (R-h)^2}}{R-h} \right) \right] - \\ &- mg \sin \left[\omega_e t + \varphi_0 + \arctg \left(\frac{\sqrt{\rho^2 - (R-h)^2}}{R-h} \right) \right] \end{aligned} \quad (12)$$

where ρ – relative position coordinate particles (its current radius of position); R – maximum rotor radius, or distance between the axis of the rotor and the surface of the tape conveyor belt; h – the height of the layer of bulk product on conveyor belt; $\omega_e = \frac{V}{R}$ – angular rotation speed rotor with blades; V – speed of movement conveyor belt with material on it; k – coefficient particle sliding friction on the surface shoulder blades; m – particle mass; g – acceleration free fall.

Thus, the differential equation the process of particle sliding along a curved blade surfaces in a certain sector of angles. The rotation of the scapula is formulated. Remains to find out in which sector of the situation blades this process takes place.

2.3 Valid process sector particle slip

Expression (12) contains the initial angle φ_0 installation of the blade on the surface of which begins to slip particles of material. Obviously, with such an initial angle it is advisable to assign an angular position blades at the moment of its end point exit from an array of material as shown in (Figure 4).

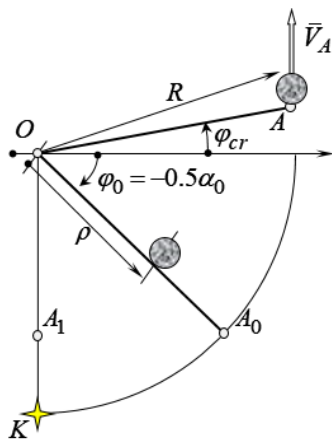

Fig. 4. Towards a process sector definition particles sliding along the surface of the scapula.

But in this case, the value of the initial angle in which begins the process of sliding particles on the surface of the blade at the accepted beginning angular position will be half of the reference angle taken with a negative sign:

$$\varphi_0 = -0.5\alpha_0 \quad (13)$$

In the process of sliding particles on the surface blades when it rotates around the axis of the rotor it is necessary to determine the maximum permissible rotation angle value φ_{cr} . This criteria the angle is determined by the safe ejection condition the last particle from the surface of the scapula. Absolute speed direction particles after its discharge from the scapula should not facilitate the fall of the particle to the surface subsequent rotor blades. Based on this conditions take the value of the criteria angle equal to zero:

$$\varphi_{cr} = 0 \quad (14)$$

Using boundary constraints (13) and (14), it becomes possible to analysis on the result of the decision differential equation (12) with the goal selection of device geometry and its modes movement. Investigation of particle slip along the surface of the blade is made for the sector blade position determined inequality:

$$\varphi_0 \leq \varphi \leq \varphi_{cr} \quad (15)$$

Outside the range (15), the slip process itself slow last particle over the surface the blades will be considered unacceptable.

Place on the working surface of the scapula several particles on equal radial distances from each other and analyze the process of their sliding on the surface of the blade in according to inequality (15).

Solution of the differential equation (12) we will carry out for each of the selected particles by numerical methods.

When illustrating the results, we will take into account the uniformity of rotation of the rotor with shoulder blades by law:

$$\varphi(t) = \varphi_0 + \omega_e \cdot t = \varphi_0 + \frac{V}{R} \cdot t \quad (16)$$

in the valid range:

$$-0.5\alpha_0 \leq \varphi \leq 0 \quad (17)$$

For calculations, we'll use the program written in accordance with equation (12) and (17). The calculation results are shown in Figure 5 for the following basic parameters:

- the number of particles on the blade in uniform radial distribution – 5;
- the outer radius of the rotor with blades is 1 m;
- the coefficient of friction the surface of the scapula is 0.4.

We accept the value of independent variables parameters:

- the speed of the conveyor belt with an array material – 10 m/s;
- coefficient of fineness of the rotor with blades (the ratio of the height of the layer of material to the outer the radius of the rotor with blades) – 0.2 (such thus, in this case, the height of the layer of material 200 mm).

The radius of the initial position of the point increases with an increase in its index. Point zero index in the initial position located in the area of the rotor hub with blades.

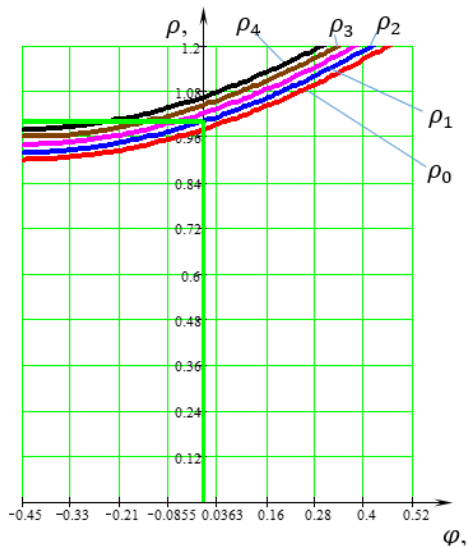

Fig. 5. The selected parameters of the variables fully support unloading.

Selected variable parameters fully support unloading the angle of rotation of the blade, corresponding condition (15) looks like a rectangle φ_{cr} , bounded by a corner to the right and a radius from above R . If upon reaching the blade criterion angle φ_{cr} is the slowest particle on the blade (with a zero index) it did not leave, those did not reach the radius R , then this means that some slow particles in the process rotor rotations with blades do not toss in the direction of movement of the conveyor.

These particles fly out in such a way that again rotor traps and fall into the entry area blades into an array of material. Thus, the criterion of appropriateness and device efficiency meets the case when all the curves leave the rectangular region without crossing its right border.

After separation of the particles of bulk material from the surface of the scapula, it starts loose flight in the air under the action of acquired kinetic energy. Separation of each particle happens at a specific time when reaching a certain the current angle of the blade (Figure 6).

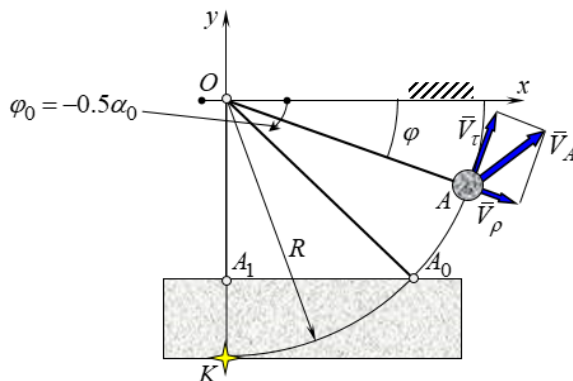

Fig. 6. On the determination of the particle velocity vector when it is separated from the scapula.

On the determination of the velocity vector particles at its separation from the scapula in accordance with the law of addition of speeds we have the vector equality:

$$\vec{V}_A = \vec{V}_\tau + \vec{V}_\rho \quad (18)$$

where \vec{V}_A – is the vector of absolute particle velocity in the moment of its departure from the surface of the scapula; \vec{V}_ρ – vector of radial particle velocity; \vec{V}_τ – vector of tangent speed particles.

Both vector terms can be calculated in its absolute value from the following ratios:

$$|\vec{V}_\tau| = V \quad (19)$$

$$|\vec{V}_\rho| = \frac{d\rho}{dt} \quad (20)$$

Expression (20) is determined on the basis of the found differential solution equations (12).

In the projection on the axis of the absolute coordinates xOy with taking into account the negativity of the angle φ , equality (18) will take the form:

$$\begin{cases} V_{Ax} = -V \sin \varphi + V_\rho \cos \varphi \\ V_{Ay} = V \cos \varphi + V_\rho \sin \varphi \end{cases} \quad (21)$$

After determining the projections of the absolute particle velocities and taking into account the angular position blades solve the differential equation movements of each particle and find for each of them the law of motion before they fall on material surface.

$$\begin{cases} x = \int V_{Ax} dt + C_x \\ y = \int V_{Ay} dt + C_y \end{cases} \quad (22)$$

Integration constants are determined by initial conditions at the initial moment time:

$$\begin{cases} x(0) = R \cdot \cos \varphi \\ y(0) = R \cdot \sin \varphi \end{cases} \quad (23)$$

The distance from the axis of the rotor to the place of impact of each particle at time T along the surface material on the conveyor is determined:

$$L = x(T) \quad (24)$$

In this case, the vertical coordinate of all the fallen particles will be the equal

$$y(T) = h - R \quad (25)$$

Thus, the definition of longitudinal surface area material moving along with the conveyor belt ribbon can be considered defined.

An example of calculating the sieving zone with the previous initial conditions of movement of the rotor and belt the conveyor is shown in Figure 7.

From the obtained dependencies and, accordingly, Figure 7 scattering parts, we can conclude that effective material excavation will depend heavily on geometric dimensions of the wheel, speed transporting material and its height to conveyor belt, as well as physical mechanical properties of the processed product characterized by a coefficient of friction slip.

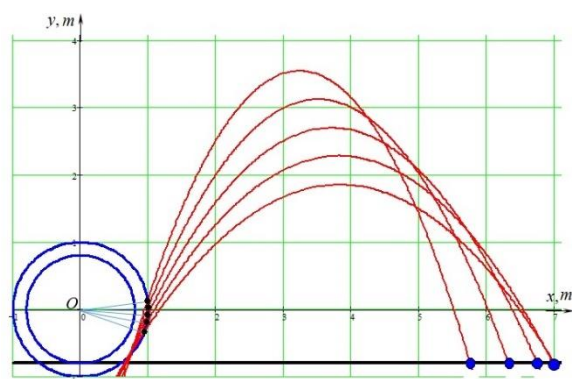

Fig. 7. Particle scattering with one blade for a given rotor.

3 Conclusion

The paper presents a mathematical model, which allows us to analyze the material's movement – “conveyor-mixer” systems and choose its rational parameters, promoting homogeneity of raw materials used in various technological metallurgical production processes.

References

1. S. Grishchenko, A. Grinev, L. Tuboltsev, Problematic issues of development of the mining and metallurgical complex of Ukraine. *Metallurgical and Mining Industry* 1, 2–6 (2017)
2. V. Lyalyuk, D. Kassim, I. Lyakhova, V. Sokolova, Coke quality and optimization of the composition of the coal charge. *Girnichy visnik* **96**, 136–140 (2013)
3. D. Popolov, I. Zaselsky, Yu. Vitetnov, Prospects for the improvement of designs of continuous rotary mixers. *International Journal Acta Universitatis Pontica Euxinus, Special Edition*, 2, 136–138 (2015)
4. A. Uchitel, D. Popolov, I. Zaselskiy, Determination of technological and power parameters mixer homogenizator. *Metallurgical and Mining Industry* 1, 158–162 (2016)
5. O. Uchitel, V. Zaselsky, D. Popolov, I. Zaselsky, *Convenient Technology and Ownership of Agglomeration Violation* (R. A. Kozlov Publishing House, Kryvyi Rih, 2018)
6. E. Shmeltser, V. Lyalyuk, V. Sokolova, I. Lyakhova, D. Kassim, M. Kormer, On the influence of the quality of preparation of coal blends on the strength and granular composition of coke. *Girnichy visnik* **99**, 128–133 (2015)
7. M.Yu. Tarshis, B.M. Korolev, A.B. Kapranova, The modeling of a grain materials mixing process in the circulating type devices, in *Interuniversity collection of scientific papers* (Yaroslavl State Technical Univeristy, Yaroslavl, 2016), pp. 242–250
8. M. Volkov, M. Tarshis, A. Zaitsev, Study of an open-type bulk materials mixer with working blades, *Chemistry and Chemical Technology* **56**(11), 117–119 (2013)
9. D.M. Borodulin, Modelirovanie nepreryvnogo protessa smesheniia sypuchikh materialov s sootnosheniem smeshivaemykh komponentov 1:100, in *Innovatsionnyi konvent “Kuzbass: Obrazovanie, nauka, innovatsii”* (Kemerovo, 2012), pp. 18–21.
10. D.M. Borodulin, Dissertation, Kemerovo Technological Institute of Food Industry, 2003
11. V. Ivanets, D. Borodulin, A. Andryushkov, Trends in the development of continuous mixing equipment of centrifugal type. *Food Engineering* 1(20), 71–74 (2011)
12. A. Shushpannikov, D. Borodulin, S. Zlobin, S. Rokosov, Design Features of Continuous Lifting Vibratory Screw Mixers. *Food Engineering* 2(29), 102–106 (2013)