

Control of technical state of mine hoisting installations

Serhii Ilin¹, Larysa Adorska^{1,*}, David Pataraja², Volodymyr Samusia³, Svitlana Ilina³, and Mykhailo Kholomeniuk³

¹Institute of Geotechnical Mechanics named by N. Poljakov of National Academy of Sciences of Ukraine, 49005, Dnipro, Simferopolska Str., 2a, Ukraine

²LEPL G. Tsulukidze mining institute, 0186, Tbilisi, Mindeli Str., 7, Georgia

³Dnipro University of Technology, 49005, Dnipro, Yavornytskoho Ave., 19, Ukraine

Abstract. The article deals with the monitoring of the technical condition of the equipment of mine shaft lifting rigs that have been in operation for more than 50 years in rock movement zones. The analysis of the state of the profiles of the conductors of mine shafts with a long service life is performed. A solid model of barrel reinforcement and the results of calculations and distribution of stress concentration along the length of the shot are presented. The results of measuring the residual tiered wall thicknesses of the conductors and shots, as well as the residual values of the kinematic gaps in the track of the conductors between their working surfaces and the slip shoes of the vessel are presented. The results of measuring the dynamic parameters of the vessel-reinforcement systems under the conditions of active trunks are presented. The main provisions for the organization of a monitoring system for the equipment of mine shafts are developed.

1 Introduction

With long-term operation of hoisting systems in mine shafts with complex mining and geological conditions, the main task is to ensure the safety of their operation. This is accomplished through organization of a complex system of measures, which is based on obtaining the most complete and objective information about the actual parameters of operating equipment, predictive calculation of their possible change in a direction of increasing the risk of an accident [1].

Obtaining initial information about the conditions and factors that occur during the operation of shafts, making local assessments and identifying general laws of processes that affect safety of their operation, is performed based on the analysis of existing materials accumulated during the previous comprehensive surveys, instrumental surveys, and special performed measures that form the initial information base.

As a result of analytical and assessment-based constructions, a conceptual assessment of functioning of a hoist complex maintenance system and a level of risks during the shaft operation under given technological conditions are performed. The procedure for assessing

*Corresponding author: adors@i.ua

the state of this complex is as follows:

- a review of the current condition of shaft operation and a level of staff training;
- assessment of instrumental measurements of verticality of guides, wear of guides and buntons, and geometrical parameters of a track;
- optical-visual assessment of a shaft equipment condition;
- special instrumental measurements of the smoothness of the movement of hoisting vessels;
- a detailed assessment of the results of instrumental measurements combined on a computer, considering the data obtained from optical-visual surveys;
- assessment of a condition and a level of risk during the shaft operation.

The survey is performed in a complex with a detailed analysis of a workload of the hoisting complex using a specially developed methodological support and technical means [2 - 4].

The aims of the work are:

- analysis of stem conductor system profiles operating under difficult conditions in rock movement zones;
- development of a solid-state model of barrel reinforcement and stress concentration calculations along the length of the execution;
- assessment of the measurement results of the kinematic and dynamic parameters of the vessel-reinforcement systems under the conditions of active trunks;
- development of the main provisions for the organization of a monitoring system for mine shaft equipment;
- predictive assessment of the effectiveness of the implementation of a monitoring system for mining equipment.

2 Methods

As a result of realization of this approach, at the stage of analyzing operational documentation and data from previous surveys, first of all, the state of system of profiles of mine shaft guides is analyzed. Their curvatures are caused by the displacement of rocks and can reach significant values.

Figure 1 and 2 show typical schemes of cross-sections of shafts that have been in operation for more than 50 years in the zones of rock displacement.

Characteristic graphs of spatial profiles of guides of a coal shaft are shown in Figure 3, ore-hoisting shaft – in Figures 4 and 5.

Figure 3a illustrates a characteristic action of displacement of rocks in a coal massif – the difference in absolute coordinates at the top and bottom of the shaft in a lateral plane of guides reaches 1400 mm, and in a frontal plane (Figure 3b) this difference is only 120 mm at a shaft depth of 550 m.

Allowable values of this parameter are different in different countries. For example, in some European countries it should not exceed 35 mm at a depth of 1000 m and 45 mm at a depth over 1000 m.

Figures 4 and 5 show the influence of displacement trough of rocks in the ore-hoisting shaft. It is seen that in a case of ore massif, the absolute difference in absolute coordinates at the top and bottom of the shaft in a lateral plane of guides reaches 160 mm, in a frontal plane (Figure 5) this difference is 60 mm at a shaft depth of 1200 m.

These data are initial for further mathematical processing and calculation of diagnostic parameters that determine the character of dynamic interaction of vessels and reinforcement and its safety in a dynamic mode.

Figure 6 shows the solid model of the defective reinforcement section.

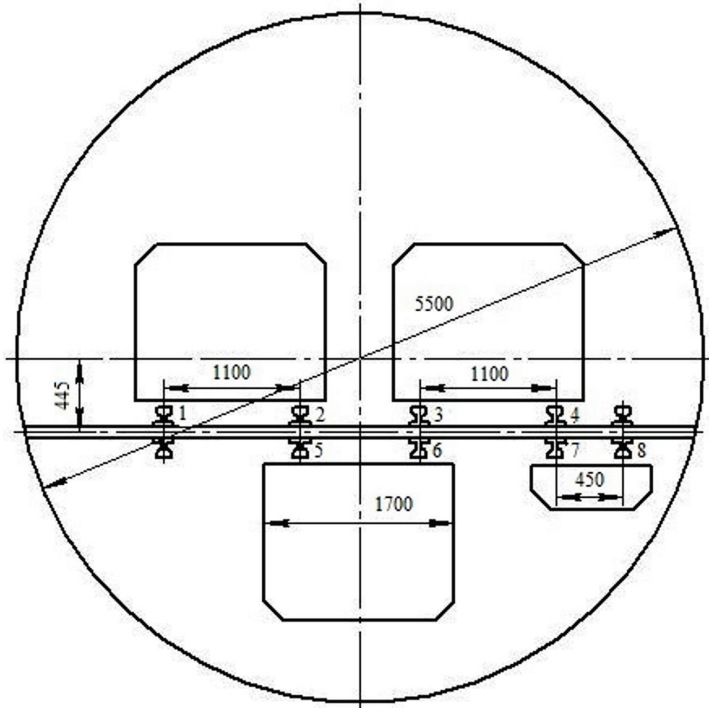

Fig. 1. The cross section of the coal barrel in the zone of displacement of rocks.

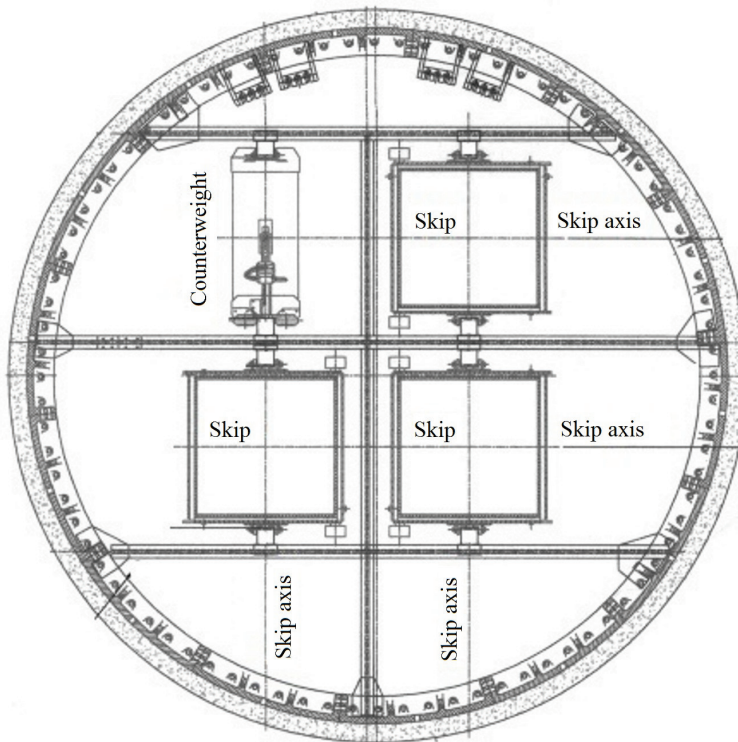
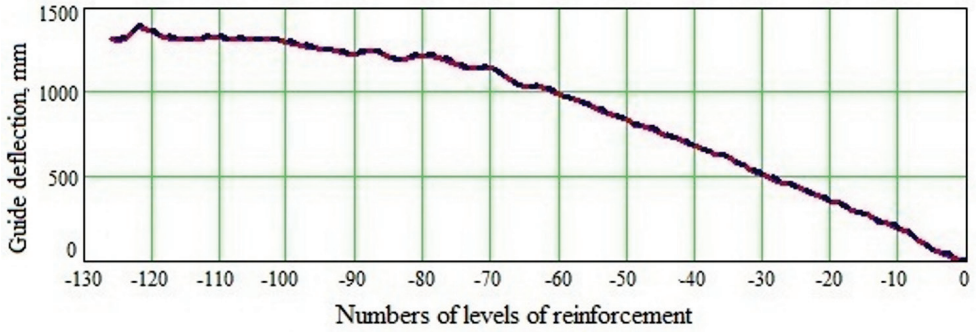
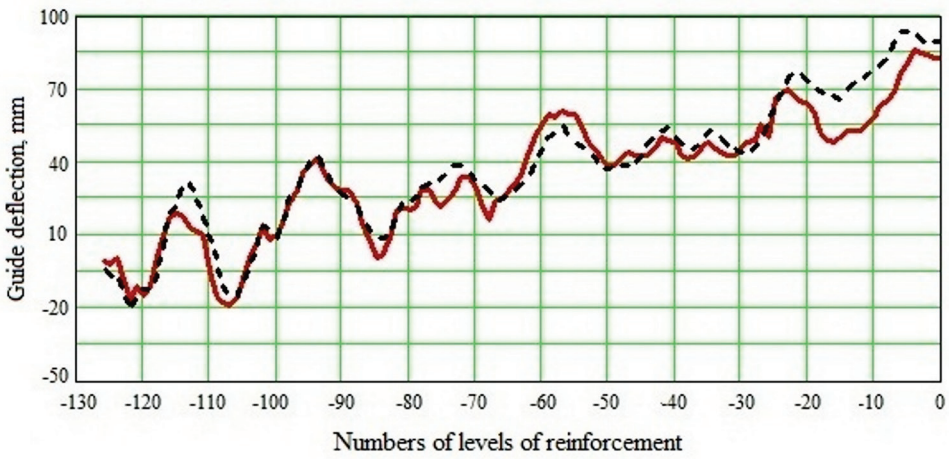

Fig. 2. Section skip shaft in the zone of movement of rocks.



(a)



(b)

Fig. 3. Profiles of a coal skip shaft guides after 55-60 years of operation: (a) in a lateral plane of the guides; (b) – in a frontal plane of the guides.

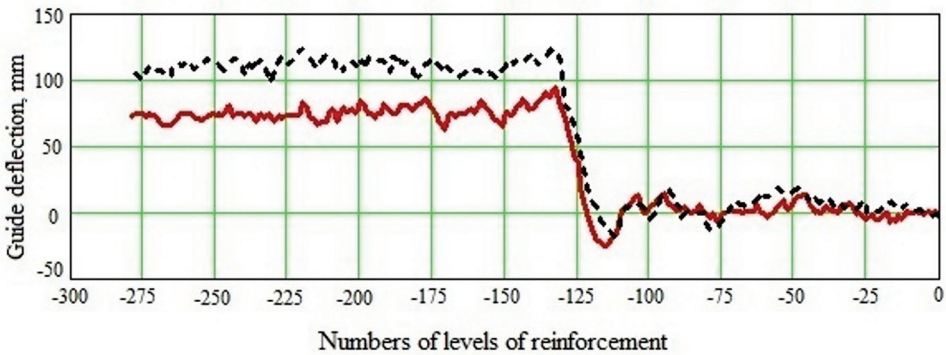

Fig. 4. Profiles of guides of an ore shaft in a zone of rock displacement of an ore-hoisting shaft in a lateral plane of guides.

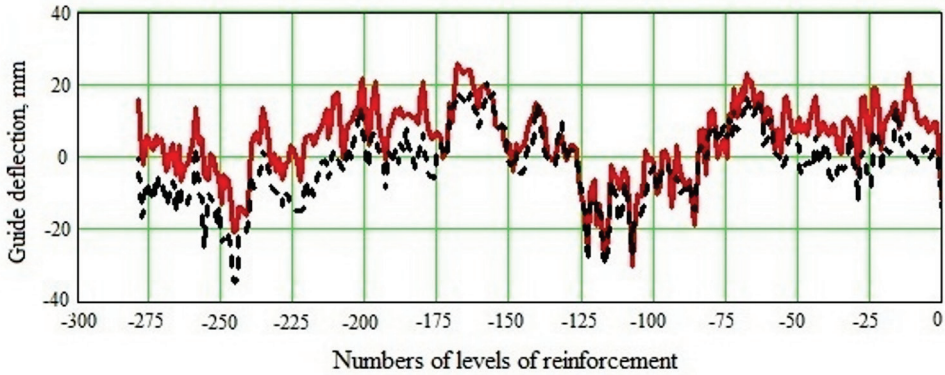

Fig. 5. Profiles of guides of an ore shaft in a zone of rock displacement of an ore-hoisting shaft in a frontal plane of guides.

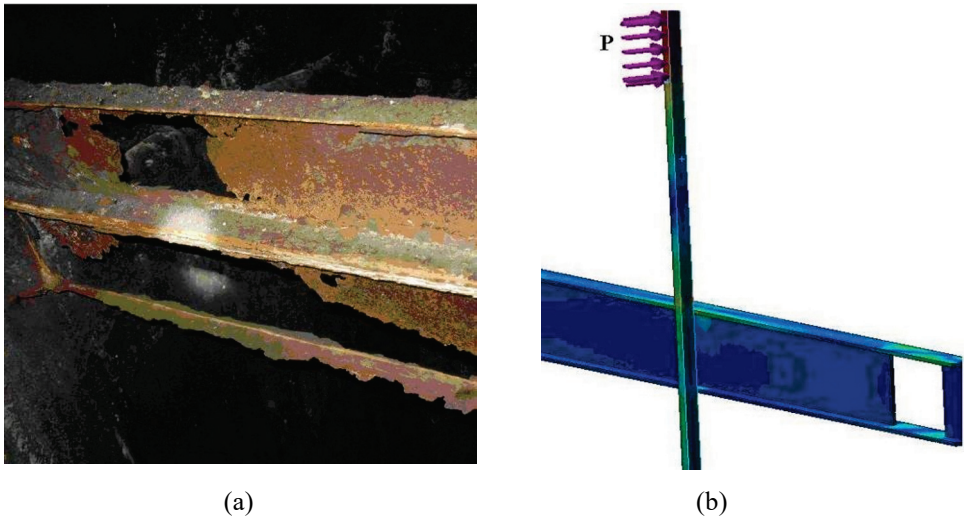

Fig. 6. Defects of buntions during long-term operation in aggressive mine environments: (a) – photographic materials; (b) – solid model of a guide-buntion system with a local defect.

These include: level-by-level values of deflection of guides from the vertical on adjacent levels to the side (Δ_i^B , mm) and in the front (Δ_i^L , mm); broadening/narrowing of a track on a level (ΔL_i , mm) ($\Delta L_i < 0$ corresponds to narrowing, $\Delta L_i > 0$ – to broadening), angles of inclination of guides to the vertical in a frontal (α_i^L , rad) and in a lateral (α_i^B , rad), planes; angles of track axis rotation (γ_i , rad).

$$\begin{aligned}
 \Delta L_i &= L_i - L_0; & \Delta_i^B &= X_i - X_{i-1}; & \Delta_i^L &= Y_i - Y_{i-1}; \\
 \alpha_i^L &= (X_i - X_{i-1})/h_i; & \alpha_i^B &= (Y_i - Y_{i-1})/h_i; & \gamma_i &= (Y_i - Y_{i-1})/L_0; \\
 \delta\alpha_i^L &= (\alpha_i^L - \alpha_{i-1}^L)/h_i; & \delta\alpha_i^B &= (\alpha_i^B - \alpha_{i-1}^B)/h_i; & \delta\gamma_i &= (\gamma_i - \gamma_{i-1})/h_i;
 \end{aligned} \quad (1)$$

where i – the number of reinforcement level in a shaft; L_i – the value of a track width on an i level, m; L_0 – basic track width, m; X_i , Y_i – deflection of guides from the vertical in frontal and lateral planes of guides respectively; h_i – distance between reinforcement levels,

mm; $\delta\alpha_i^L$, $\delta\alpha_i^B$ – relative frontal and lateral angles of inclination of guides to the vertical respectively; $\delta\gamma_i$ – relative angle of rotation of a track axis.

Figure 6a shows photographic materials of monitoring the state of reinforcement in one of the existing ore shafts, obtained during expert examination. Figure 6b shows a solid model of the reinforcement section with imitation of a worn out section of a flange of an I-beam buntun under the action of a percussive dynamic load on a guide in a frontal plane.

Relative geometrical parameters of profiles of guides have a major influence on a character and intensity of dynamic interaction of vessels with reinforcement. Their values with standard deflections of guides from the vertical on adjacent levels of ± 10 mm were chosen as a reference ones. In addition, the values of residual cross-sections of guides and reinforcement buntuns after selective repairs are determined on each level as initial data for analysis.

Simulation modeling of a complex of dynamic processes in a shaft equipment of hoisting installations on a basis of polyparametric measurement of initial data during their operation is an effective tool for predicting the possible accumulation of degradation effects and identifying their concentration areas. Solid modeling allows performing this on a modern level with sufficient certainty [5].

3 Results and discussion

Figure 7 shows the results of measurement of residual tempered thickness of the walls of the conductors (a) and executions (b).

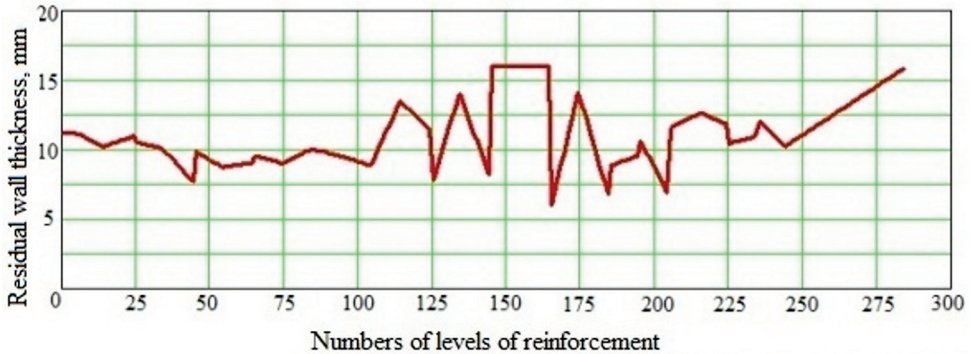

(a)

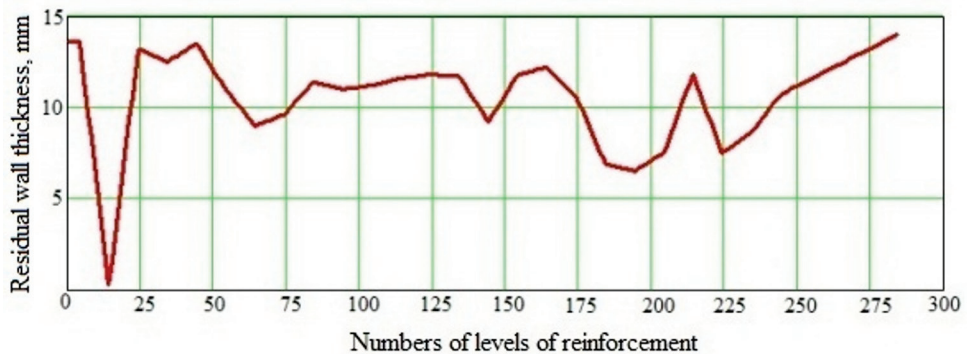

(b)

Fig. 7. Residual sections of conductors (a) and executions (b) of the ore shaft.

Figure 8 shows the residual values of kinematic gaps in the track gauge between their working surfaces and vessel slip pads.

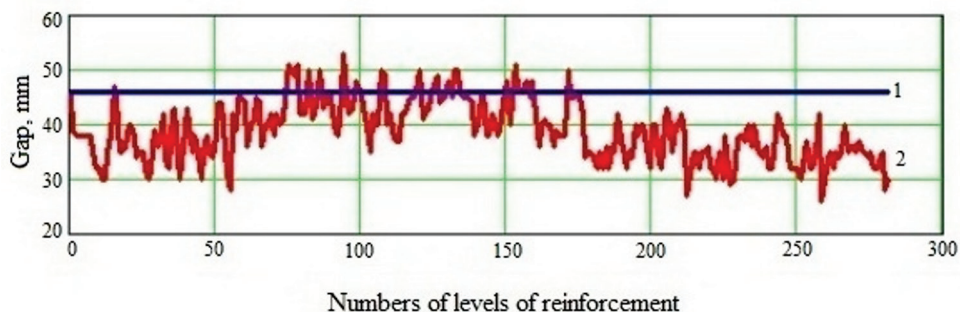

Fig. 8. Frontal gaps between conductors and sliding guides: 1 – maximum permissible level, mm; 2 – actual clearances, mm.

From these data it can be seen that in a course of operation, as a result of the total impact of rock displacement and selective repairs, some local areas of reduced strength of bearing elements are created in shafts.

This is areas with a high level of reinforcement elements wear, as well as areas where conditions are created for an emergency reduction of conditions for kinematic engagement between shaft guides and vessel guides (frontal gaps exceed the allowable level) due to the curvature of guides.

Figure 9 shows the characteristic graphs of parameters calculated by the formulas (1) based on the data of survey profiling of guides for coal and ore shafts.

In these figures, the areas of violation of the normative and reference values of the deviations of the conductors from the vertical on adjacent tiers in the frontal plane for coal and ore shafts are marked.

Also, in a monitoring process, the parameters of dynamic interaction of vessels with reinforcement are measured continuously along the depth of shafts on a series of test cycles of descent/ascent.

If a hoisting installation is equipped with a stationary system of contactless dynamic sensors that measure horizontal accelerations of sliding guides, kinematic gaps between shaft guides and vessel guides, and transfer readings to the hoisting mechanic server, their readings accumulated over a long time are the initial data for further system risk-oriented analysis of a level of hoist operation safety [6 - 10].

Figure 10 and 11 show the graphs of horizontal accelerations of vessel guides in lateral and in frontal planes of reinforcement along the five operation cycles of descent of an empty and ascent of a loaded skip.

It can be seen that the pattern of acceleration amplitudes in a lateral plane exceeding accelerations in a frontal plane is repeated in all cycles. It is in the lateral plane that the intense influence of displacement trough of rocks in a shaft occurs, as shown in Figure 11a. It is seen that amplitudes of accelerations in the middle part of the shaft are, for the most part, almost twice as large as in the upper and lower parts of the shaft.

In the same part, total frontal gaps in "sliding shoe guide" pairs have the greatest values along the shaft depth, which contributes to intensification of a percussive-dynamic interaction process.

Figure 12 shows a graph of distribution of values of stress concentration coefficient (SC) along the length of a bunton. The graph shows that in this case a stress concentrator is formed in the area of defect zone, the voltage in which is twice the voltage in the rest of the execution [5, 11].

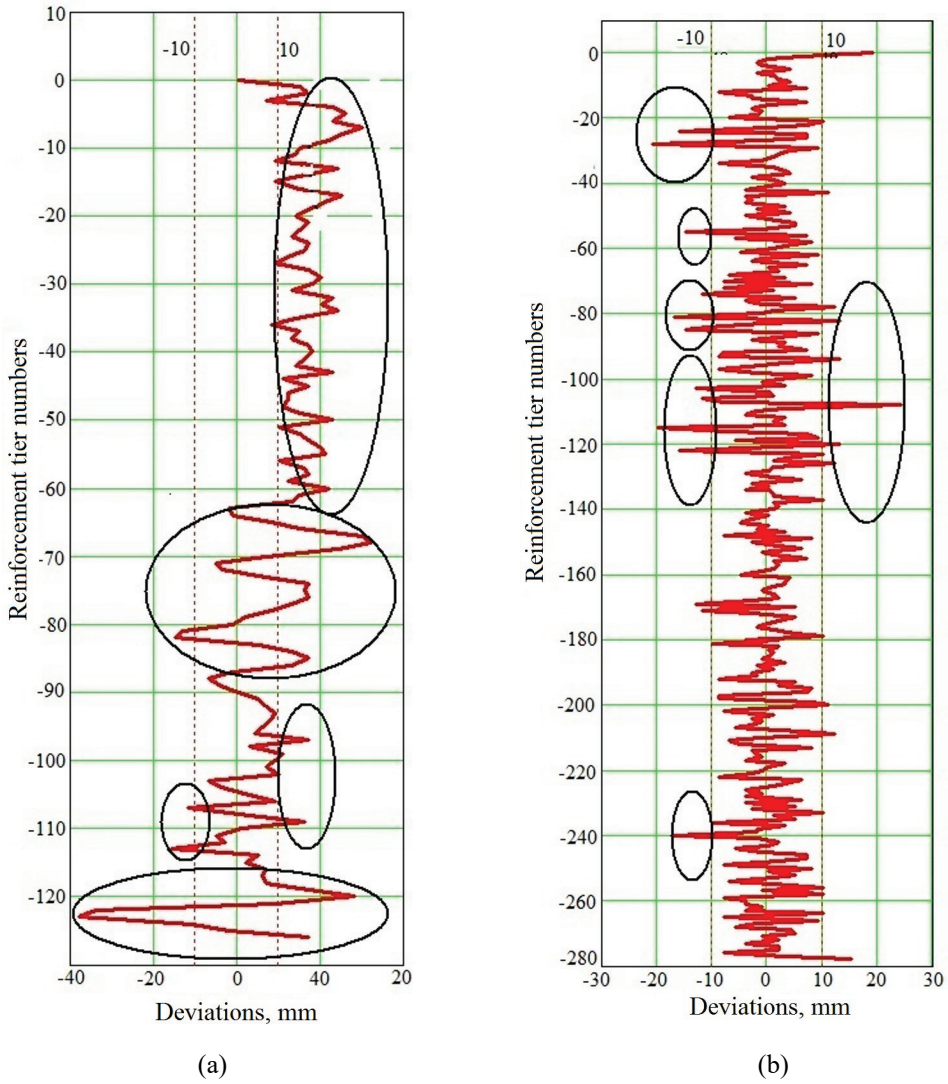

Fig. 9. Geometric parameters of guide profiles: deflections from the vertical on adjacent levels in a frontal plane of a coal shaft (a); ore shaft (b).

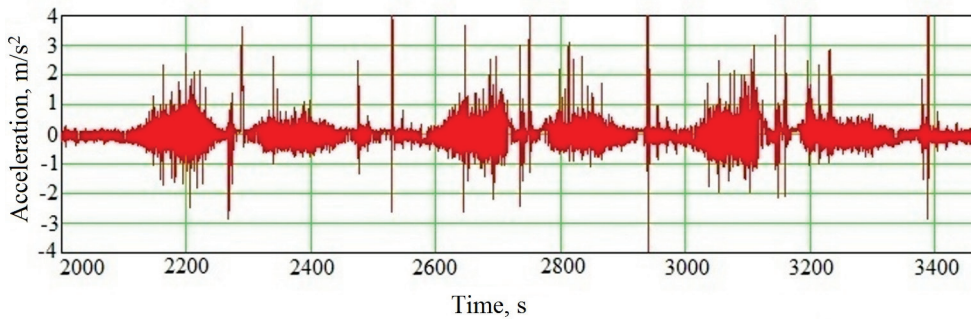

Fig. 10. Horizontal accelerations of vessel guides in lateral planes of reinforcement.

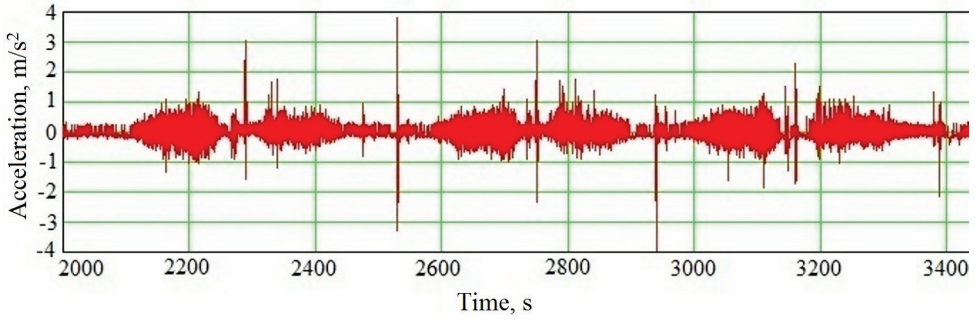

Fig. 11. Horizontal accelerations of vessel guides in frontal planes of reinforcement.

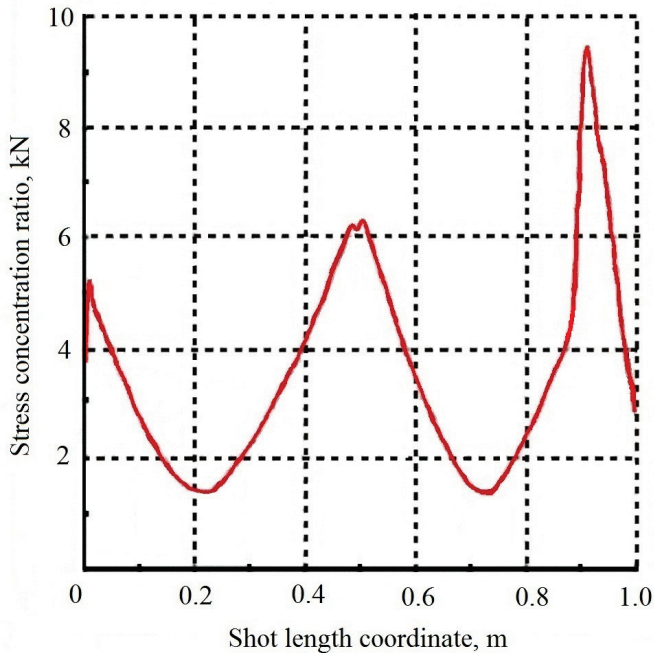

Fig. 12. Graph of distribution of stress concentration coefficient values along the length of a buntion with a defect.

Figure 13 shows a multiparameter fragment of combined data of dynamic contact forces on guides, movement velocities and position of a vessel in a shaft during a series of four cycles of skip descent/ascent.

This information allows experts to obtain the most objective data on the interaction of several parameters at once, the degree of intensity of their changes, and the danger level of manifestations of various processes and conditions.

Having received such information, an expert can promptly develop recommendations on managerial measures, the order and terms for their realization to eliminate the violations found and the causes of these violations, based on the most accurate data.

The results of measurements of physical and mechanical parameters of equipment and reinforcement of shafts are presented in a form of tabular materials, diagrams, graphs, conclusions and recommendations, including materials from surveying the sections of local violations and potentially hazardous sections of reinforcement.

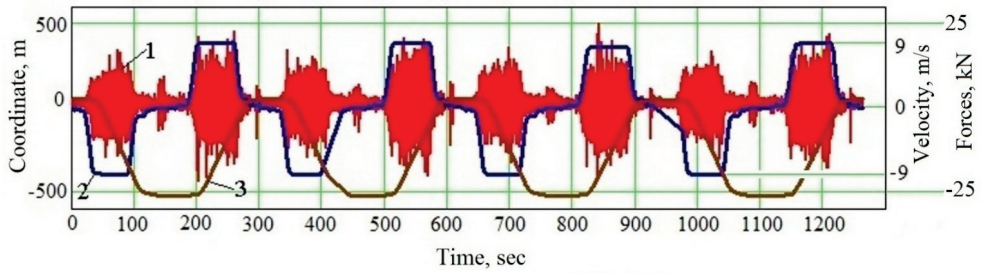

Fig. 13. Summary diagram of skip parameters: contact forces, velocities and coordinates in a shaft: 1 – forces, kN; 2 – velocity, m/s; 3 – coordinate in a shaft, m.

One of the most important elements of monitoring and risk management system is the development and usage of modern computer-oriented means of measuring, collecting and accumulating information.

Risk management is performed through a system of recommendations for organizational and technical measures at the enterprise developed on a basis of monitoring data. This improves the operation safety of shafts, optimizes the cost of their repairs and significantly reduces the total amount of work.

The creation of a monitoring system is carried out on the basis of construction of an information model of the shaft based on determination of condition of its elements with multi-parameter express control of the most important characteristics.

The methodological basis for formation of information models of deep mine shafts is a multifactor analysis of data describing the current condition and discrete changes in time of characteristics of various elements of the shaft, having the following functions:

- creation and replenishment of a database of instrumental measurements of dynamic and physical and geometrical parameters of operating hoisting shaft equipment;
- assessment of the current condition and quality of operation of shafts;
- identification of technical and organizational solutions that can improve the work safety in shafts;
- determination of effective and safe modes of movement of hoisting vessels;
- predictive assessment of the influence of repair and maintenance work on changes in the level of emergency hazard of shaft operation;
- multifactor analysis of the influence of a set of dynamic, geometric, modal and other parameters of hoisting equipment on the safety indicators of shaft operation;
- technical inspection of the shaft as an object of increased danger;
- creation and maintenance of a database with ranking by the level of emergency hazard of operation of ore-hoisting shafts of the region.

The basis of the monitoring and risk management system is the instrumental control of a dynamic condition and strength parameters of the "hoisting vessel-reinforcement" system, which integrally reflects the condition of almost all elements of the shaft. It is possible to determine the bulk of sections of violations in the shafts based on the results of surveying the characteristics of dynamic perturbations of hoisting vessels. In combination with multi-parameter analysis, that includes data on guide and buntton wear, geometrical parameters of a shaft guide system profiles, velocity modes of hoisting operation, kinematic parameters of engagement of vessel clamping elements and the guide, it is possible to determine the emergency risk in the sections of the shaft and develop recommendations to reduce it to a safe level.

A software and hardware complex, multi-channel microprocessor-based measuring equipment and software tools for data accumulation and processing were developed to perform such measurements. The system should ensure saving the events of the last ten

cycles of the hoisting machine in random access memory, ensure the possibility of subsequent analysis of fixed data entered into the system memory bank, automatic diagnostics of functional elements, organization of control tests and indication of malfunctions. The described equipment is intended for usage at a stage of introduction of new or reconditioned equipment and its parts; its application indicates individual features that are characterized by initial parameters, which are further considered during the entire period of operation, starting at the time of run-in [12-19].

In general, the block diagram of such a diagnostic system is shown in Figure 14.

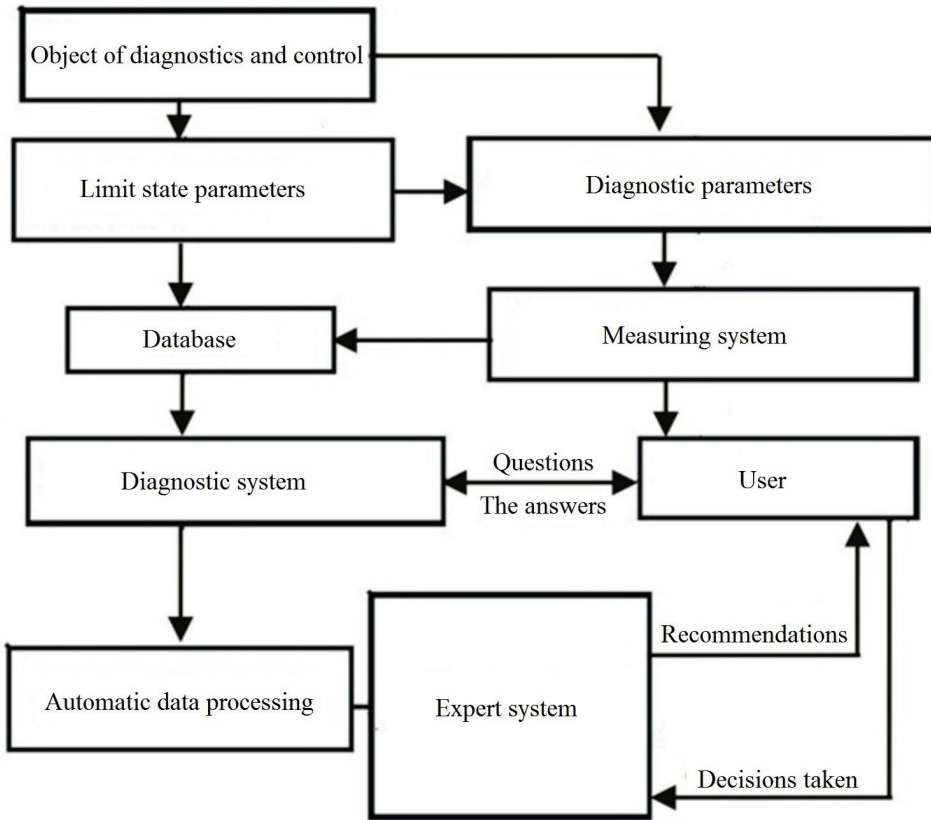

Fig. 14. Block diagram of the expert diagnostic system of mine hoists.

4 Conclusions

Analysis of the profiles of the conductors of mine shafts that have been in operation for more than 50 years in the zones of rock movement showed their excess deviation from the vertical. This is one of the risk factors in the operation of mine hoisting installations and requires a series of measures to control and manage the technical condition of the mine hoist to ensure its safety and reliability. Profiling data are the source for subsequent mathematical processing and calculation of diagnostic parameters that determine the nature of the dynamic interaction of vessels and reinforcement and its safety in a dynamic mode.

The solid-state model of barrel reinforcement made it possible to simulate a complex of dynamic processes in the barrel equipment of hoisting installations and to calculate stress concentration along the length of the shot. According to the results of measuring the

kinematic and dynamic parameters of the vessel-reinforcement systems under the conditions of active shafts, the residual sections of conductors and shots, frontal gaps between the conductors and guides and the parameters of the dynamic interaction of the vessels with the reinforcement are determined. This allows you to identify areas with reduced strength of the supporting elements, as well as areas in which, due to the curvature of the conductors, emergency-hazardous conditions are created for kinematic engagement between the conductors and the guiding vessels. These data, accumulated over a long time, are the source for the subsequent systematic analysis of the level of safety of mine hoist operation.

The end result of the monitoring system realization is the development of recommendations for conducting managerial maintenance and repair works in the shafts, ensuring their safe operation and optimization of corresponding works. This is performed on the basis of the results of a comprehensive expert analysis of data obtained through instrumental measurements and optical-visual survey of a current condition of elements of shafts, periodically entered into the database during the monitoring process [20].

Taking into account modern aspects of rock mechanics in conditions of increasing coal mining intensity [21, 22], the implementation of a mine-lifting equipment monitoring system will allow:

- reducing the risk of spontaneous accidents due to uncontrolled accumulation of degradation damage to equipment in a shaft when operating at design velocities;
- developing justified individual values of allowable levels of operational parameters of "vessel-reinforcement" systems, which operate for a long time in deformable shafts with a disturbed geometry;
- significantly increasing the level of industrial safety of operation of mine hoisting complexes in complex mining and geological and technical conditions.

References

1. Diagnostics of the state of the systems of "attachment-array" and "lifting vessel-rigid reinforcement" of mine shafts. Procedure and method of execution. (2004). *GR 3-032-2004. Ministry of Industrial Policy of Ukraine*, 40
2. Ilin, S.R., Ilina, S.S., Samusia, V.I. (2014). Mine lifting mechanics. *Minister of Education and Science of Ukraine. National Mining University*, 247
3. Ilin, S.R., Adorska, L.G., Samusia, S.V. (2014). Ensuring the safety of the mine rises in the shafts under complex mining and geological and mining conditions. *Geotekhnicheskaya Mekhanika [Geo-Technical Mechanics]*, (119), 20-35
4. Ilin, S.R., Radchenko, V.K., Adorska, L.G. (2017). Risk-forming processes during the operation of mine hoisting installations. *Geotekhnicheskaya Mekhanika [Geo-Technical Mechanics]*, (134), 22-33
5. Ilina, S.S. (2010). Modeling the dynamics of the vessel-reinforcement system. *Problems of operation of equipment of mine stationary installations. VNIIGM them. M.M. Fedorov. Donetsk*, (104-105), 56-78
6. D. Kolosov, O. Bilous, H. Tantsura, S. Onyshchenko. Stress-strain state of a flat tractive-bearing element of a lifting and transporting machine at operational changes of its parameters. *Solid State Phenomena*, (277), 188-201 (2018)
7. D. Kolosov, O. Dolgov, A. Kolosov. Analytical determination of stress-strain state of rope caused by the transmission of the drive drum traction. *Progressive Technologies of Coal, Coalbed Methane, and Ores Mining*, 499-504 (2014)
8. D. Kolosov, O. Dolgov, O. Bilous, A. Kolosov. The stress-strain state of the belt in the operating changes of the burdening conveyor parameters. *New Developments in Mining*

- Engineering 2015: Theoretical and Practical Solutions of Mineral Resources Mining*, 585-590 (2015)
9. I. Belmas, D. Kolosov. The stress-strain state of the stepped rubber-rope cable in bobbin of winding. *Technical and Geoinformational Systems in Mining: School of Underground Mining 2011*, 211-214 (2011)
 10. Belmas, I.V. (1993). Stress state of rubber-rope tapes during their random damages. *Problemy Prochnosti i Nadezhnosti Mashin*, (6), 45-48
 11. Ilina, S.S. (2017). The impact of violations of the integrity of elements of I-beams on the strength of the shaft shaft reinforcement. *Geotekhnicheskaya Mekhanika* [Geo-Technical Mechanics], (137), 107-116
 12. Ilin, S.R., Samusia, V.I., Kolosov, D.L., Ilina, I.S., Ilina, S.S. (2018). Risk-forming dynamic processes in units of mine hoists of vertical shafts. *Naukovyi Visnyk Natsionalnoho Hirnychoho Universitetu*, (5), 64-71
 13. Guidelines for the calculation of the braking moment and the verification calculation for non-slip of the ropes in the modes of safety braking of hoisting machines with a friction pulley. (1984) *USSR Ministry of Coal Industry. VNIIGM them. M.M. Fedorov*. Donetsk, 78
 14. Method of calculating rigid reinforcement of vertical shafts. (1994). *VNIIGM them. M.M. Fedorov*. Donetsk, 169
 15. Ilin, S.R., Samusia, V.I., Ilina, I.S., Ilina, S.S. (2016). Influence of dynamic processes in mine hoists on safety exploitation of shafts with broken geometry. *Naukovyi Visnyk Natsionalnoho Hirnychoho Universitetu*, (3), 42-47
 16. S.R. Ilin, V.I Samusia, I.S. Ilina, S.S. Ilina. Influence of dynamic processes in mine winding plants on operating safety of shafts with broken geometry. *Theoretical and practical solutions of mineral resources mining*. (Taylor & Francis group, 2015)
 17. Bondarenko, V.I., Samusia, V.I., Smolanov, S.N. (2005). Mobile lifting units for wrecking works in pit shafts. *Gornyi Zhurnal*, (5), 99-100
 18. Ilin, S.R., Adorska, L.G., Posled, B.S. (2011). Measuring and analytical computer technology for diagnosing and managing the condition of equipment in mine lifting complexes. *Geotekhnicheskaya Mekhanika* [Geo-Technical Mechanics], (93), 28-38
 19. S.R. Ilin, L.G. Adorska, V.K. Radchenko, B.S. Posled, I.S. Ilina, S.S. Ilina. The Experience Of Dynamic Apparatus Control And Estimation Of Exploitation System Safety "Vessel – Reinforcement" Of Vertical Mining Shafts. *Transport szybowy. Instytut Techniki Gornicej* (2013)
 20. S. Ilin, L. Adorska, V. Samusia, D. Kolosov, I. Ilina. Conceptual bases of intensification of mining operations in mines of Ukraine based on monitoring and condition management of mine hoisting systems. *E3S Web of Conferences, International Conference Essays of Mining Science and Practice*, **109** (2019). <https://doi.org/10.1051/e3sconf/201910900030>
 21. O. Voloshyn, O. Riabtsev. Some important aspects of rock mechanics and geomechanics. *E3S Web of Conferences, International Conference Essays of Mining Science and Practice*, **109** (2019). <https://doi.org/10.1051/e3sconf/201910900114>
 22. O. Krukovskiy, Y. Bulich, Y. Zemlianaia. Modification of the roof bolt support technology in the conditions of increasing coal mining intensity. *E3S Web of Conferences, International Conference Essays of Mining Science and Practice*, **109** (2019). <https://doi.org/10.1051/e3sconf/201910900042>