

Planning and Design of a PV-Battery Microgrid System for Improving the 22 kV Radial Distribution System of the Sichang Island in Thailand

Yutthana Suyalue^{1,2*} and Umarin Sangpanich²

¹Green-Smart Energy Technology (G-SET) Research Group, Kasetsart University Sriracha Campus, 20230 Chon Buri, Thailand

²Provincial Electricity Authority (PEA), 10900 Bangkok, Thailand

Abstract. Voltage drop and energy loss issues in remote areas will degrade the reliability of power system when loads are subsequently increased. This paper aims to design a PV-Battery microgrid system to enhance the performance of the 22 kV radial distribution system of the Sichang island, which is situated remotely in the Gulf of Thailand. The locations and capacities of the PV-Battery microgrid systems were determined based on voltage regulation and limited feeder rating following the Provincial Electricity Authority (PEA) standard and projected energy loss reduction for increasing load demand within the next twenty years. The DigSILENT Power Factory were used for the simulation. From survey and simulation results, these locations are technically suitable for installation. A capacitor bank system should be installed at the end of power-line branch with the suitable sizing of 1.5 MVar. A microgrid PV-Battery system should be installed with a PV array of 1.5 MWp at the cape area and batteries of 1.08 MWh at the PEA operator center, and batteries of 1.44 MWh and 5.28 MWh at the starting point of the island's distribution line.

Keywords: Battery, energy loss, overvoltage, photovoltaic, renewable energy.

1 Introduction

Voltage drop and energy loss problems in remote areas are the causes of unreliability in a power system as loads are increasing because there may lead to an unstable voltage during high load consumption. In the case of long distribution lines, voltage and energy loss can be mitigated by extending distribution lines to share load of existing systems. The extension of distribution lines though, has high initial construction cost, especially for the power systems of island areas. Moreover, in order to reach the island area, the construction of submarine cable is needed, and so an environmental impact assessment must be conducted. Alternatively, a microgrid can be used for alleviating voltage drop and energy loss problems.

*Corresponding author: umarin@eng.src.ku.ac.th

A microgrid is a localized group of distributed generations (DG) and loads that usually operate connected to and synchronous with the traditional electrical power system network, but it can also operate even when disconnected from the network. The microgrid can be designed for increasing the effectiveness of renewable energy [1] and expanding rural electrification [2]. The suitable location of energy storage system in a feeder was proved affecting on the system performance of microgrid consisting of renewable energy. Single-phase PV microgrids were designed for remote villages in developing countries, where an energy demand is low [2]. The design considered voltage profiles and power losses and compared between industrial standard PV system design software PVsyst™ and free online tool PVGIS5. A graph-partitioning and an integer-programming integrated method for optimal planning of a loop-based microgrid topology was proposed [3]. HOMER is used for microgrid planning design [4]. Multi-objective optimization of droop-controlled islanded microgrid was proposed [5–7]. From a review of microgrid research [8], reliability improvement, environmental impact and economic feasibility should be evaluated for microgrid planning by considering the concept of demand side management including energy efficiency and demand response.

This paper aims to design a PV-Battery microgrid system to enhance the performance of the 22 kV radial distribution system of the Sichang island. The Sichang island is situated remotely in the Gulf of Thailand. In 2010, electrical power was delivered to both the Sichang island and onshore by the radial distribution feeder No.10 of the Ao-Phai power substation. It was connected to the Sichang island by a submarine cable of 10.3 km. The total feeder distance from the onshore substation to the Sichang island is approximately 17.3 km. In 2017, the submarine cable was broken, however, it has been repaired accordingly [9]. At present, diesel generators are being used for power generation on the Sichang island. Therefore, a provision for the future peak demand is needed. Extending distribution lines to share load of existing systems could alleviate the voltage drop and energy loss issues but the construction cost of distribution lines is expensive, especially for those connecting the grid to the power system on the island. Furthermore, an environmental impact assessment for the submarine cable construction must also be conducted. Alternatively, with careful planning for the appropriate installation site and battery capacity, a PV system can be used instead of distribution lines extension.

The appropriate locations and capacities of a PV-Battery microgrid and a capacitor bank were determined based on voltage regulation in a range of 22 kV ± 5 % and limited feeder rating of 8 MW following the Provincial Electricity Authority (PEA) standard and projected energy loss reduction for increasing load demand within the next twenty years. The DigSILENT Power Factory and Hybrid Optimization Model for Electric Renewables (HOMER) programs were used for the simulation. Furthermore, the Sichang island was surveyed to find the suitable sites for the practical installation of a PV array, battery stations, and a capacitor bank.

2 Microgrid impact on voltage and power losses

This paper selected the shunt capacitor bank for the voltage regulation at the load bus because of their low investment and operating cost. If a shunt capacitor and DG are located in grid systems, as shown in Figure 1, the voltage at bus i on the feeder at time t can be calculated as follows in Equation (1) [10]:

$$V_i = \left(\frac{1}{Y_{ii}}\right) \left[\frac{P_i - jQ_i}{V_i^*}\right] - \sum_{k=1, k=i}^n Y_{ik} V_k \quad (1)$$

where V_i is the voltage at bus i (V), Y_{ii} is the admittance at bus i , P_i is the active power at bus i (W), Q_i is the reactive power at bus i (Var), Y_{ik} is the admittance between bus i and k and V_k is the voltage at bus k (V).

The capacitor appropriately compensates for the reactive power demand and the DG system generates the active power, the feeder current at time t will be decreased, leading to a decrease in the power losses in the feeder at time t ($P_{loss}(t)$) as follows, in Equation (2) and Equation (3):

$$P_{loss(i,i+1)}(t) = [(P_{L(i,i+1)}(t) - P_{G(i,i+1)}(t))^2 + (Q_{L(i,i+1)}(t) - (\pm Q_{G(i,i+1)}(t)) - Q_{c(i,i+1)}(t))^2] * R_{i,i+1} \quad (2)$$

$$P_{sys,loss}(t) = \sum_i^{n-1} [P_{loss(i,i+1)}(t) + P_{T,loss}(t) + P_{equip,loss}(t)] \quad (3)$$

Where $P_{L(i,i+1)}(t)$ is the load active power (W) between buses i and $i+1$, $Q_{L(i,i+1)}(t)$ is the load reactive power (Var) between buses i and $i+1$, $Q_{c(i,i+1)}(t)$ is the shunt capacitor generating reactive power between buses i and $i+1$ at time t (Var), $P_{G(i,i+1)}(t)$ and $Q_{G(i,i+1)}(t)$ are the active and reactive power of DG system between buses i and $i+1$ at time t , respectively, $R_{i,i+1}$ is the line resistance (Ω) of the line section connecting buses between buses i and $i+1$, $P_{loss(i,i+1)}(t)$ is the power loss (W) of the line section connecting buses between buses i and $i+1$, $P_{sys,loss}(t)$ is the total system loss, $P_{T,loss}(t)$ is the transformer loss and $P_{equip,loss}(t)$ is the equipment loss at t time.

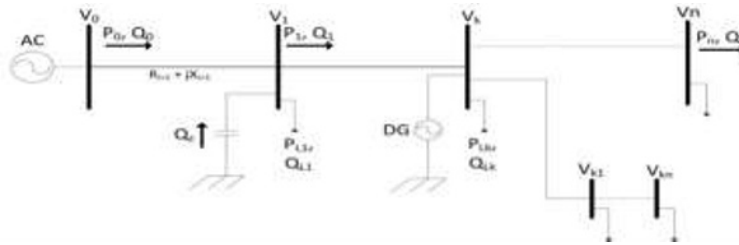

Fig. 1. One-line diagram of a radial system having DG and capacitor banks [11].

3 Method

The planning aims to investigate the suitable location and capacity of a PV array and a battery system to regulate voltage levels of $22 \text{ kV} \pm 5 \%$ following the PEA standard and to decrease energy losses in the feeder. Furthermore, power flows in each distribution line in a range of 8 MW were considered. The PEA load prediction was used [12]. The investigation process can be described as follows.

- (i). Survey the real island area for remarking the appropriate and possible locations of PV array and battery system installation.
- (ii). Collect, simulate, and analyze data of the Sichang island distribution system.
- (iii). Design, simulate, and analyze micro-grid PV-Battery systems in different capacities and locations by using the DigSILENT and HOMER programs.
- (iv). Analyze the simulation results and make a recommendation for the appropriate installation plan of the micro-grid system in the period of 20 yr.

4 Electricity of Sichang Island

This paper aims to design the micro-grid PV-Battery system for improving the 22 kV radial distribution system of the Sichang island. The Sichang island, also known as Koh Sichang, is located in the Gulf of Thailand shown in Figure 2(a). The distance between the Sichang island and onshore is approximately 10 km. Planning and design of PV and battery

capacities and locations are determined by considering voltage regulation and energy loss reduction for increasing load demand in the future.

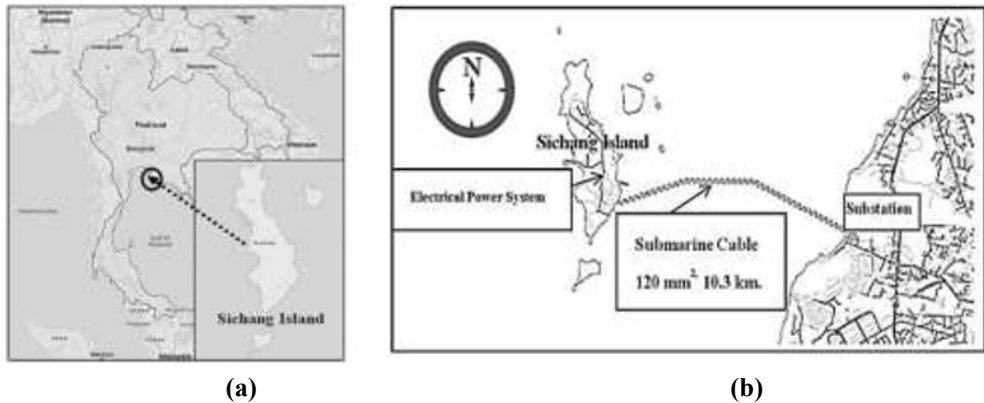

Fig. 2. (a) A geographic map of Sichang island (b) the submarine feeder cable from GIS for electrical systems of PEA.

4.1 Distribution feeder specification

The data of the real 22 kV radial distribution submarine feeder cable of Sichang island was exported from the Geographic Information System (GIS) for electrical systems of PEA presented in Figure 2(b) [13]. The feeder No. 10 of 115/22 kV 40 MVA transformer in the Ao-Phai power substation had delivered electrical power to load of both Sichang island and onshore since 2010 shown the single-line diagram in Figure 3 [14]. However, the submarine cable was broken and has been repaired since 2017 [9]. Presently, diesel generators are used for supporting load of Sichang island. The submarine cable has a cross-section area of 120 mm² and a distance of 10.3 km. Distribution lines on the island are spaced aerial cable (SAC) type and have a cross-section area of 185 mm² and a total distance of 9.4 circuits-km.

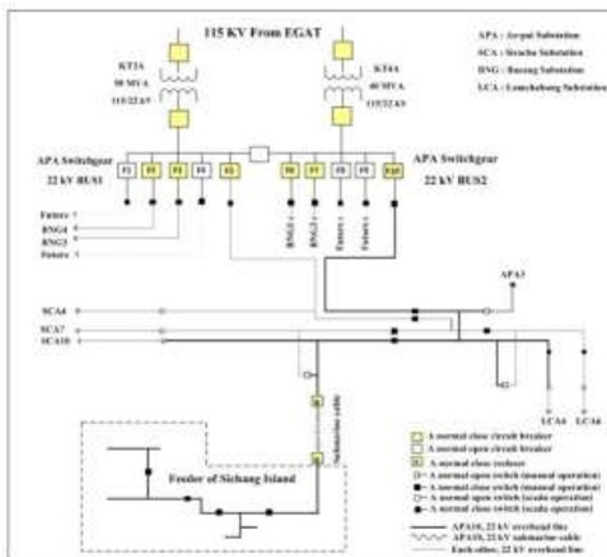

Fig. 3. Single-line diagram of Ao-Phai power substation and the distribution feeder of Sichang island.

4.2 Load demand data and prediction of Sichang island

The Sichang island has a Royal Palace built by King Chulalongkorn (Rama V) in 1892 and beach resorts popular amongst tourists, especially in the Songkran festival. The peak demand happened at around 7 pm during the Songkran festival was 1.82 MW, 1.95 MW and 2 MW in 2016, 2017 and 2018, respectively [15]. Average peak demand increases approximately 0.12 MW yr^{-1} . This simulation analysis was based on a long-term load forecasting covers a period of 20 yr starting from 2019 to 2038 by the Electrical System Analysis and Planning Division of PEA [12]. Profiles of maximum daily load energy in the Sichang island and onshore of feeder No.10 occurred on April 13th, 2018 were presented in Figure 4 [16]. The total load energy consumptions of Sichang island were 8.35 GWh yr^{-1} , 8.94 GWh yr^{-1} and 9.17 GWh yr^{-1} in 2016, 2017 and 2018, respectively [17].

The load profile of onshore in the feeder No. 10 in 2019 to 2038 was assumed to be equal to the load profile of 2018. The rationale behind this assumption is that if the load demand of onshore is increased, a system operator will divide load demand increased to other feeders.

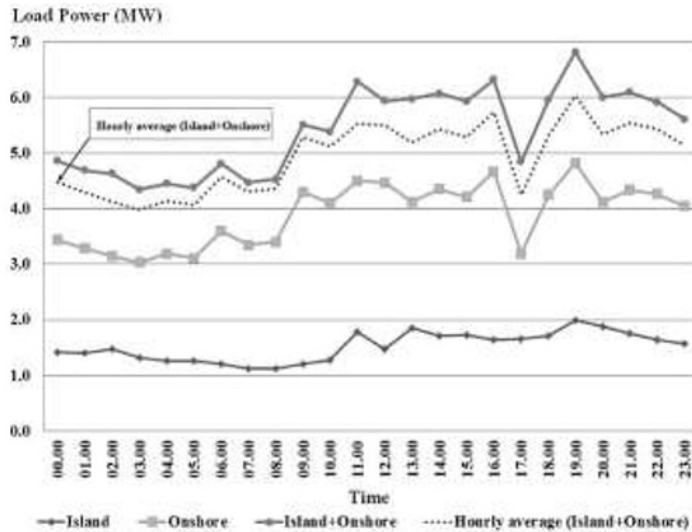

Fig. 4. Load profiles of peak demand occurring on April 13, 2018 and hourly average of load profile in 2018 at Sichang island and onshore [16].

5 Micro-grid PV-battery system

5.1 Photovoltaic module

The polycrystalline silicon 320 Wp modules, having an efficiency of 16.5 %, are used in this paper. The manufacturer guarantees a lifetime of 25 yr. From the solar radiation data and the location, PV modules should be oriented facing the South with an optimum angle of 15° to obtain the annual maximum output energy. The PV power of 1 MWp system has the total energy of 1.56 GWh yr^{-1} estimated by using the HOMER program.

5.2 Batteries

This study uses the vented lead-acid 3 000 Ah battery, having the nominal voltage of 2 V and minimum state of charge (SOC) of 30 %. The battery system has string size of

20 battery series and nine strings paralleled. The bus voltage is 40 V. To simplify this analysis, the round-trip efficiencies are assumed as constants of 86 %. Bi-directional converter and charger efficiencies are assumed to be 90 %. Expected life is 20 yr.

6 Results and discussion

The effects of load increases in a period of 20 yr (2019 to 2038) were investigated on four study cases of power generations, namely (i) a submarine cable, (ii) a submarine cable and a capacitor bank, (iii) a submarine cable and a PV-Battery microgrid system, and (iv) a submarine cable, a capacitor bank and a PV-Battery microgrid system.

6.1 Planning to solve over voltage and overload power in the feeder

Time periods of system improvement planning were divided into four phases based on voltage regulation in a range of 22 kV \pm 5 % and limited feeder rating of 8 MW following the Provincial Electricity Authority (PEA) standard.

6.1.1 Phase I (2019 to 2025)

In the first phase, the feeder No.10 can support load both the Sichang island and onshore without any occurrences of overload and under voltage. According to the simulation results in Figure 5 and Figure 6, during 2019 to 2025, the island load can be supported solely by the submarine cable without the occurrences of under voltage and overload power in the feeder.

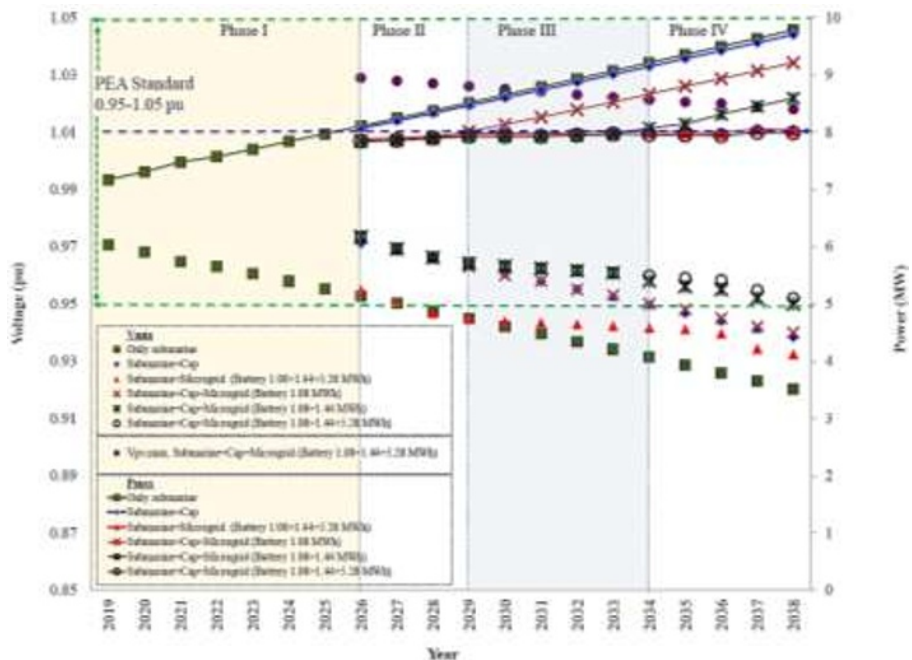

Fig. 5. Voltage and total load power levels of four study cases in each time period

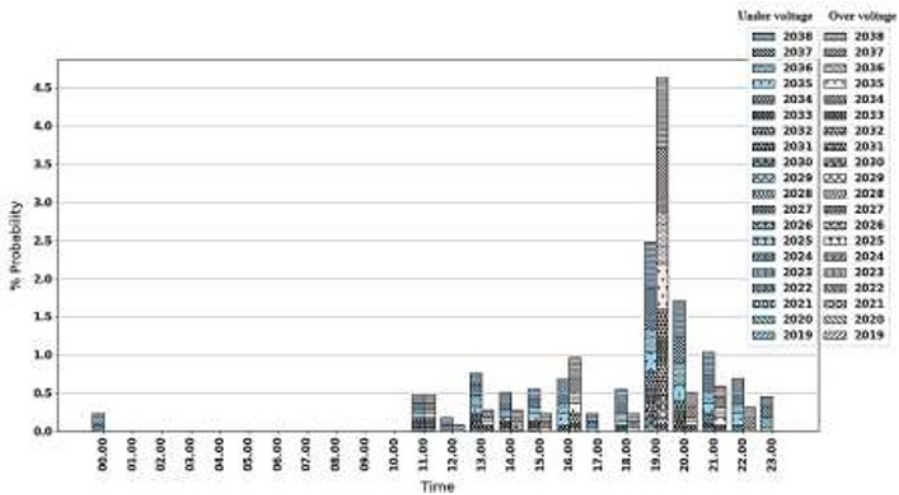

Fig. 6. The probability of over peak load and under voltage occurring in 2019 to 2038

6.1.2 Phase II (2026 to 2028)

If the island load demand is increased 0.12 MW per year following the PEA prediction, the load power levels will exceed the feeder rating after 2026 as shown in Figure 5. The most probable time of the occurrences of over peak load will be at 7 pm as shown the peak load demand in Figure 5 and the probability of overload in the feeder in Figure 6. In order to shave the peak load power, a microgrid PV-Battery system should be installed with the optimal PV array of 1.5 MWp at the cape area (C point) as shown in Figure 7. The PV simulation result as shown in Figure 8 was calculated from the load profile projected until 2038. The optimal battery capacity of 1.08 MWh (B point) was computed from the HOMER program, with the load profile in 2028. The battery station should be installed at the PEA operator center. From a survey result in Figure 7, these locations are technically suitable for installation because, as it can be seen from Figure 8, although there may not result in the minimum energy loss within the network, it could result in the absence of overvoltage problem as well as cheaper construction cost.

The under voltage will start happening from 2028 as the simulation results shown in Figure 5 to Figure 6. A capacitor bank should be installed at the end of power-line branch at A point as shown in Figure 7, with the suitable sizing of 1.5 MVar selected from the simulation results projected until 2038 as shown in Figure 9.

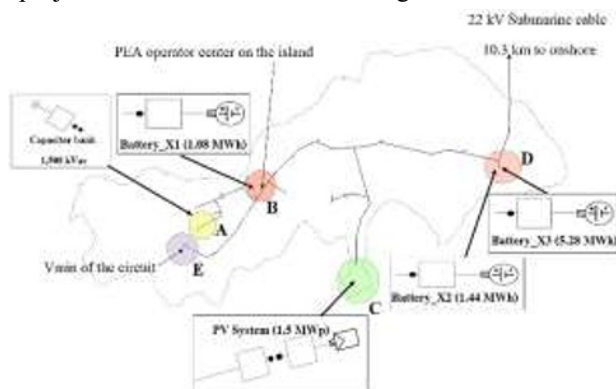

Fig. 7. The optimal location of PV-Battery microgrid system on the Sichang island

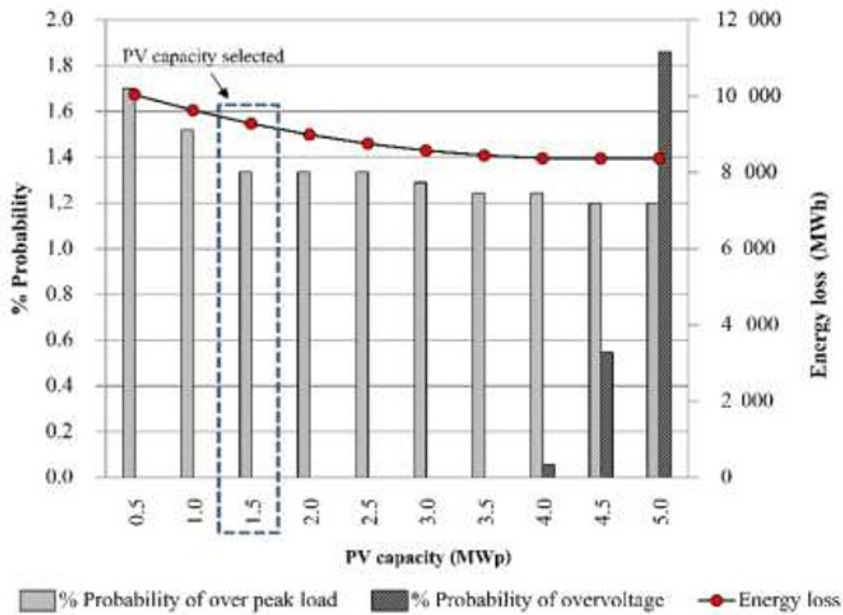

Fig. 8. The probability of over peak load and under voltage, and energy loss of various PV capacity installed.

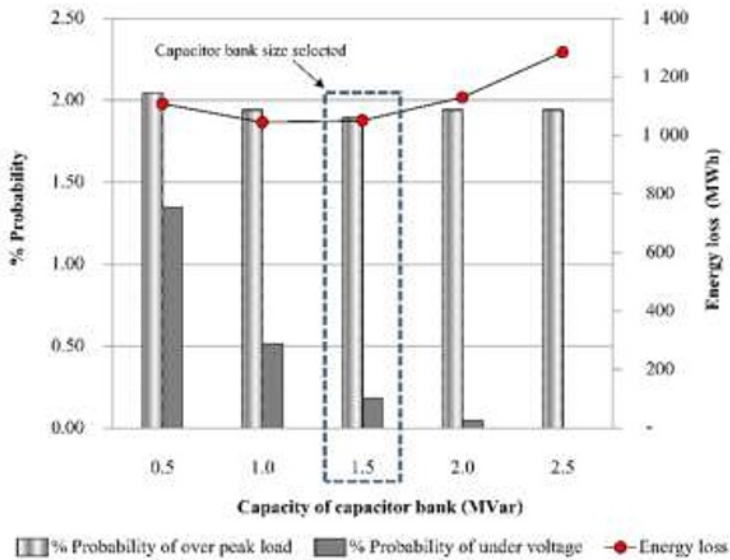

Fig. 9. The probability of over peak load and under voltage, and energy loss at the various capacitor installed.

6.1.3 Phase III (2029 to 2033)

With the increasing load demand, the power will exceed the feeder rating. Thus, from the load profile in 2033, batteries of about 1.44 MWh (D point) should be installed at the optimal location, namely at the starting point of the island’s distribution line as shown in

Figure 7. Nevertheless, as this optimal location is a privately owned land, there might be additional cost of installation.

6.1.4 Phase IV (2034 to 2038)

During 2034 to 2038, energy consumption was projected to grow such that batteries of about 5.28 MWh should be installed to meet the expected feeder rating in 2038 as shown in Figure 5. The suitable installation location is the same as the battery station of Phase III as shown in Figure 7.

6.2 Energy loss

Load demand is forecasted to grow 0.12 MWh yr^{-1} . This negatively affects the energy loss of the system. The installed microgrid system and capacitor bank can help decreasing energy losses of the feeder as shown in Figure 10, based on the optimal sizes and locations. The system improvement could reduce the energy loss of the feeder by 2.68 GWh (21.76 %) of total energy loss during 2026 to 2038.

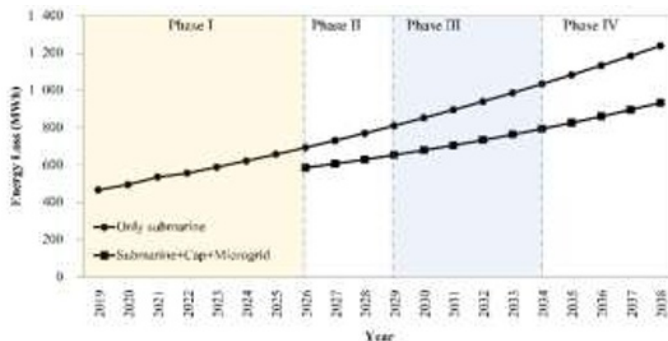

Fig. 10. Simulation results of energy loss in the feeder No.10, comparing between (i) only submarine cable, and (ii) submarine cable, capacitor bank and microgrid installation.

7 Conclusions

This paper presents a planning and design of a PV-Battery microgrid system for improving the reliability of the 22 kV radial distribution system based on site survey and data driven simulations. The Sichang island on the eastern coast of the Gulf of Thailand was chosen as a case study. The simulations were conducted to study the effects of load increases on the reliability of the distribution system between 2019 to 2038. Real circuits, load profiles data, and system operation standards were obtained from PEA. The results revealed that as the load consumption of the system is increasing, the power load levels will exceed the feeder rating after 2026 and there will be a voltage drop in the system after 2028. To solve these potential problems and to make provision for increasing load of the next 20 yr (from 2019 to 2038), it is advisable to install 1.5 MVar capacitor bank, 1.5 MWp PV array, and 1.08 MWh, 1.44 MWh and 5.28 MWh battery systems at the appropriate locations. According to this simulation, after the system improvement, the expected maximum voltage at PPC of PV is 1.029 pu (in 2026), the expected maximum power load in the feeder is 7.98 MW (in 2038), and the expected minimum voltage is 0.951 pu (in 2038). In terms of energy loss, the system could achieve a 21.76 % decrease in energy loss (or 2.68 GWh) between 2026 and 2038.

References

1. Q. Fu, L.F. Montoya, A. Solanki, A. Nasiri, V. Bhavaraju, T. Abdallah, D.C. Yu, IEEE Transaction on Smart Grid, **3**,4:2019–2027(2012).
<https://ieeexplore.ieee.org/document/6397646>
2. S.M. Bhagavathy, G. Pillai, Designs, **2**,3:33(2018). <https://www.mdpi.com/2411-9660/2/3/33>
3. L. Che, Member, X. Zhang, M. Shahidehpour, A. Alabdulwahab, Y. Al-Turki, IEEE Transactions on Smart Grid, **8**,4:1771–1781(2017).
<https://ieeexplore.ieee.org/document/7374730>
4. W. Su, Z. Yuan, M.Y. Chow, *Microgrid planning and operation: Solar energy and wind energy*, IEEE PES General Meeting, (Providence, 2010). p. 1–7.
<https://ieeexplore.ieee.org/iel5/5577387/5588047/05589391.pdf>
5. M.A.A. Abdelaziz, H.E. Farag, E.F. El-Saadany, IEEE Transaction on Sustainable Energy, **5**,2:434–445(2014). <https://ieeexplore.ieee.org/document/6709809>
6. A. Maulik, A. Das, IEEE Transaction on Sustainable Energy, **9**,3:1337–1348(2018).
<https://ieeexplore.ieee.org/document/8207635>
7. J. Jayachandranath, D. Das, IET Renewable Power Generation, **13**,5:785–800(2019).
<https://ieeexplore.ieee.org/document/8680816/authors#authors>
8. S. Parhizi, H. Lotfi, A. Khodaei, S. Bahramirad, State of the Art in Research on Microgrids: A Review, **3**,890–925(2015).
<https://ieeexplore.ieee.org/document/7120901>
9. Provincial Electricity Authority (PEA), *Meeting report of submarine cable repairing*, PEA, Bangkok, Thailand, (2017), [Internal documentation]. [Online unpublished].
10. I. A. Ethman, M. Maaroufi, A.K. Mahmoud, A. Yahfdhou, I. Youm, International Journal of Electrical Engineering (IJEE), **5**,6:9–25(2017).
<https://ipassj.org/IJEE/Volume5Issue6/IJEE-2017-06-12-2.pdf>
11. N. A. Khan, S. Ghosh, S.P. Ghoshal, International Journal of Emerging Technology and Advanced Engineering, **3**,2:220–225(2013).
<http://citeseerx.ist.psu.edu/viewdoc/download?doi=10.1.1.413.8023&rep=rep1&type=pdf>
12. Provincial Electricity Authority (PEA), *Load Forecast of The Sichang Island*, PEA, Bangkok, Thailand, (2018), p. 2–10. [Internal documentation]. [Online unpublished].
13. Provincial Electricity Authority (PEA), *Geographic information system of 22 kV distribution system_feeder no.10 Ao-Pai power substation*, PEA, Bangkok, Thailand, (2019). [Internal documentation]. [Online unpublished].
14. Provincial Electricity Authority (PEA), *Single Line Diagram of Ao-Phai Power substation*, PEA, Bangkok, Thailand, (2019). [Internal documentation]. [Online unpublished].
15. Provincial Electricity Authority (PEA), *Peak Load report for Island area*, PEA, Bangkok, Thailand, (2018). [Internal documentation]. [Online unpublished].
16. Provincial Electricity Authority (PEA), *Daily Load repo of Sichang Island*, PEA, Bangkok, Thailand, (2018). [Internal documentation]. [Online unpublished].
17. Provincial Electricity Authority (PEA), *Yearly Load report of Sichang Island*, PEA, Bangkok, Thailand, (2018). [Internal documentation]. [Online unpublished].