

# Modeling thin-walled elements with regard to steel hardening

*Natalia Korsun\**, and *Daria Prostakishina*

Industrial University of Tyumen, Department of Building structures, 625000 Volodarsky str., 38, Tyumen, Russia

**Abstract.** Today in Russia 13% of buildings are built on the basis of a metal frame. To increase the energy efficiency of the industry, the use of thin-walled steel structures is one of the most technologically advanced and efficient solutions. To ensure the bearing capacity and reduce the risks of failure of buildings and structures at the design stage, it is important to correctly assess the reliability of the system, taking into account all influencing factors. The technology for the production of thin-walled profiles determines the factors that affect their stress-strain state. Uneven distribution of mechanical properties over the cross-section of the profile: hardening in the bending corners and adjacent zones leads to an increase in the strength of the metal. The article presents the results of numerical modeling of samples from thin sheet steel with and without the effect of hardening. The object of research is a thin-walled sigma profile with a section height of 300 mm, an element length of 4500 mm, operating under compression with bending. Metal hardening values are based on experimental data obtained by the authors. The stresses and displacements obtained as a result of the simulation were analyzed in four sections along the profile length: at a distance of 0.5 m, 2.3 m, 3.0 m and 4.0 m from the support. It is concluded that the supercritical work of the element without hardening of the material occurs earlier than in the element with hardening. The maximum stresses in the element without hardening exceed the stresses in the element with hardening by more than 30%. The maximum displacements in hardening are more than three times.

## 1 Introduction

Steel construction is an indicator of the sustainability of the industry. Today in Russia 13% of buildings are built on the basis of a metal frame, however, analyzing the advantages of using a metal frame, it is possible to predict an increase in the demand for metal structures in the near future. Within the framework of sustainable development and the use of energy-efficient materials and structures, the use of light steel thin-walled structures is relevant.

Steel thin-walled structures are elements less than 4 mm thick. They are manufactured by technology of cold bending which is more energy efficient and environmentally friendly

---

\*Corresponding author: [korsunnd@tyuiu.ru](mailto:korsunnd@tyuiu.ru)

than hot-rolled steel production. Their use in construction is less costly, since it does not require complex construction equipment.

The technology of manufacturing thin-walled steel profiles by cold bending implies peculiarities of thin-sheet elements functioning. Firstly, high flexibility of the section elements causes changes in the shape of the section and increased deformability under compressive stress. Secondly, work hardening forms in the bending zone under cold deformation of the metal.

Research in the field of work of thin-sheet elements is aimed at clarifying the calculation methodology taking into account the factors of geometric variability and physical unevenness. Studies of the forms of buckling of thin-walled profiles are reflected in regulatory documents, which cannot be said about the uneven distribution of mechanical properties over the section of a cold-formed profile. Normative documents regulate the possibility of taking into account the uneven mechanical properties distribution over the cross section of the profile but suggests doing this by experiments. However, that is time consuming. The hardening coefficients and the method of their recording are not given.

A lot of foreign and Russian research works are devoted to studying the mechanical properties of roll-formed steel. G. Winter, K.W. Karren, S.J. Britvec, J. Uribe и A. Chajes [1,2] developed a method for calculating the hardening coefficient. Later the method was corrected by A.G. Kozlov[3]. Then one was corrected by V.M. Derenkovskii [4,5]. I.S. Nemkova carried out a statistical analysis of steels properties and substantiation of the design resistance in cold-formed profiles. Research results: the number of hardening zones, their location and the hardening value obtained by the author are among the most frequently used today. The results of the experimental data obtained by contemporary authors [6,7] have a wide range of hardening coefficients, from 20 to 100%, which indicates that there is no consensus among researchers on this issue.

Numerical modelling of thin-walled elements has been carried out by a significant number of scientists. Most studies have been carried out in software packages implementing the finite element method or its derivatives. Thick shells with 5 [8], 6 degrees of freedom at a node [9], as well as special finite elements were used for modelling. The plate material used is steel with a classic tensile diagram [9]. The calculation was carried out in a non-linear formulation, which allows for the analysis of the overcritical operation of the element. However, the non-uniform distribution of the mechanical properties of the steel over the cross-section of the bent section was included in the modelling conventionally.

The current topic is not only the determination of the material hardening coefficients in the sectional areas of the profile, but also the possibility of taking them into account in the numerical modelling of thin-walled elements.

The aim of this study is to develop a model of a thin-walled element which takes into account the strengthening of the material in the cross-sectional areas and its effect on the load-bearing capacity of thin-walled steel specimens.

## **2 Materials and methods**

Specimens of a thin-walled sigma profile 2.5 mm thick made of steel grade 350 were taken as the object of the study (Fig. 1). The length of the element is  $L=15h=4500$  mm. The support zone is fixed rigid, the header in the plane of least rigidity. The specimen works in axial compression with bending. Element calculation diagram is shown in Fig.1.

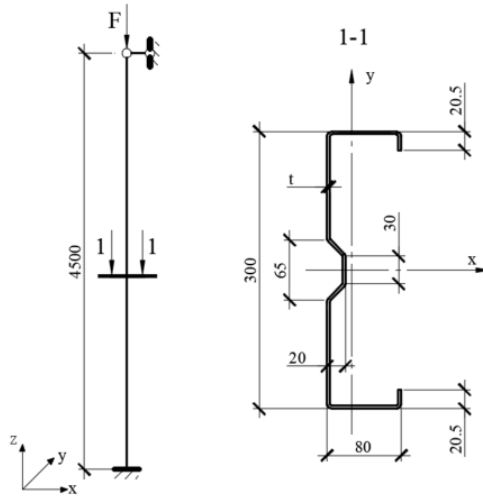

**Fig. 1.** Geometric diagram of a section. Element calculation diagram

The element material is steel-350 in accordance with GOST R 52246-2016 “Hot-galvanized sheet metal. Technical standards”. The study was carried out on two models: without material hardening (Fig.2); with material hardening determined on the basis of an experimental study carried out by the authors [10].

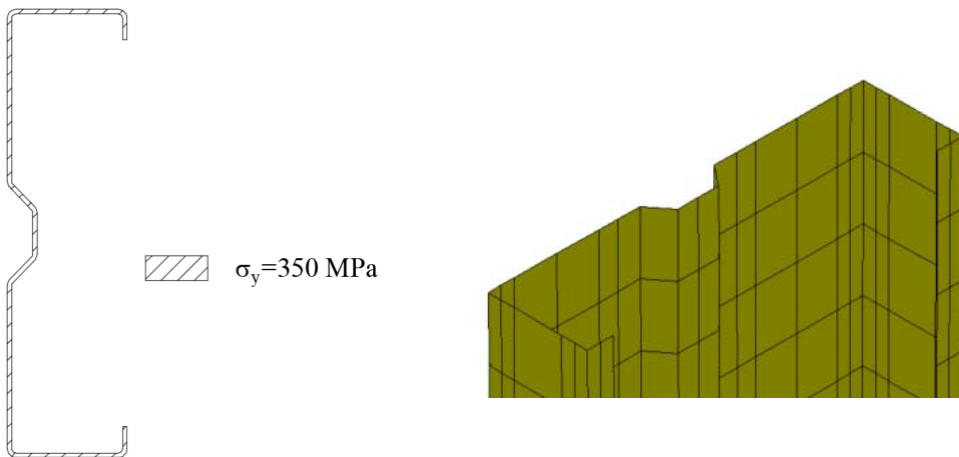

**Fig. 2.** Cross-section without material hardening

The zoning of the sample and the yield strength values for each zone are shown in Fig. 3.

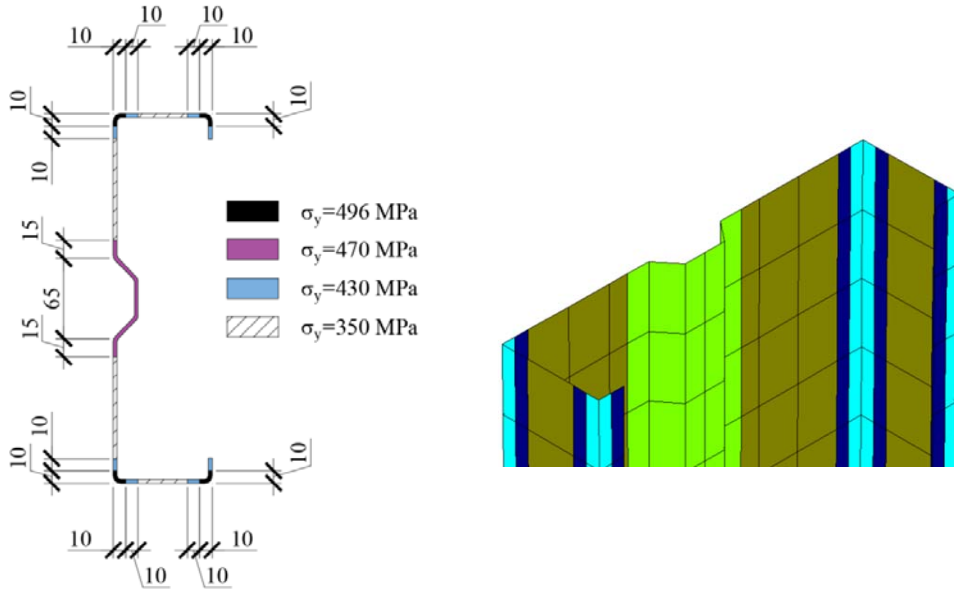

**Fig. 3.** Cross-section including material hardening

The sample was modelled using the Stark software package. The "reinforcement layer" shell material was used for the analysis of the non-linear operation of the specimen, allowing the yield strength of each zone to be taken into account. In order to verify the model and the possibility of using this type of material, a test problem was solved in the linear formulation, comparing the stresses in the model with isotropic material and the model with "reinforcing layer" material. Analysis of the results of the test problem showed a convergence of the elastic calculation stresses of up to 97%, which allowed the material "reinforcement layer" to be used for further modelling.

The magnitude of the load was determined on the basis of the stability problem and the static calculation. The critical load for stability loss in the first form was 25.5 tf. Qualitative analysis of the first form of element stability loss showed that stability loss occurs according to the general form with a loss of sectional form stability. A graphical representation with a scaling factor is shown in Fig. 4.

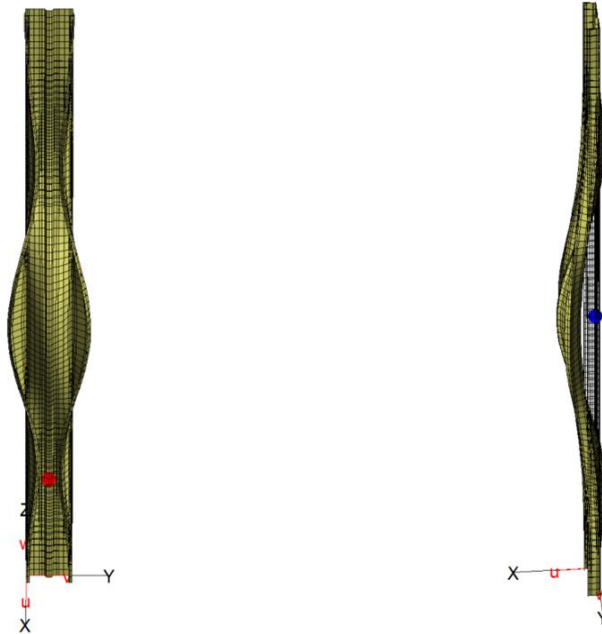

**Fig. 4.** Loss of element stability according to the first form

The sample load was increased to 32.2 tf to analyse overcritical operation. To simulate the real performance of the strut as part of the frame, the load was applied to the profile wall and the combined motions of the wall nodes in all directions up to 300 mm from the strut head were specified (Fig. 5).

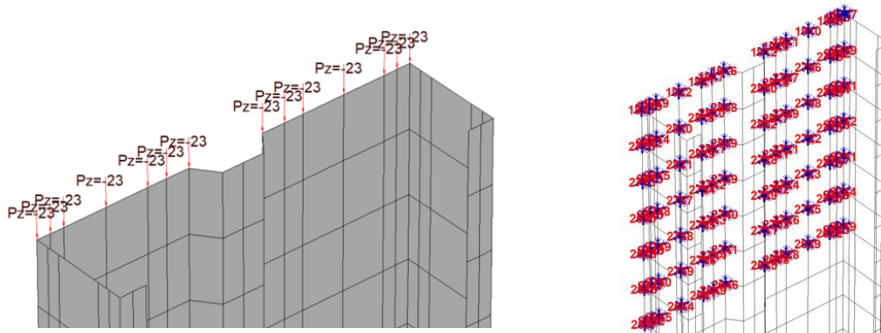
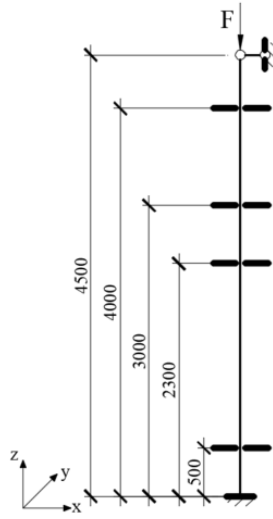

**Fig. 5.** Load shaping. Combining displacements

The static calculation was carried out in a non-linear formulation, taking physical and geometric non-linearities into account.

### 3 Results

Stresses and displacements in the cross-sectional areas of the profile were obtained as results of numerical experiment. The stresses and displacements were analysed in sections at distances of 0.5 m, 2.3 m, 3.0 m and 4.0 m from the support (Fig. 6).



**Fig. 6.** Cross-sections analysed

The stress diagrams for an element without material hardening in the cross-section are shown in Fig. 7. The transition into the plasticity zone is observed for the wall of the element. The maximum value of compressive stresses at a given load is observed in a section at a distance of 2.3 m from the support in the corner zone of the profile and is 621 MPa.

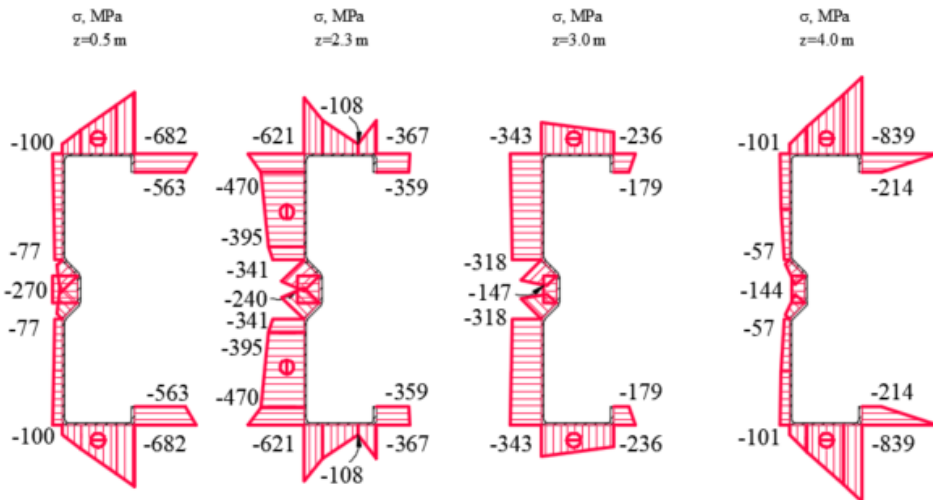

**Fig. 7.** Stresses in profile sections without reinforcement

The maximum displacement in the lowest stiffness plane - along the x-axis - was 64.2 mm (Fig. 8).

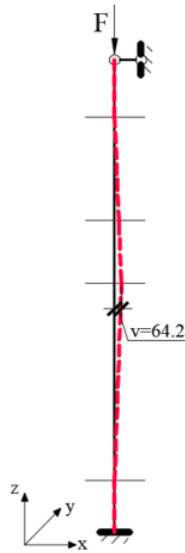

**Fig. 8.** Displacements in the element without material strengthening

The displacements in the sections are shown in Fig. 9. The maximum displacement is observed in the section at a distance of 2.3 m from the support.

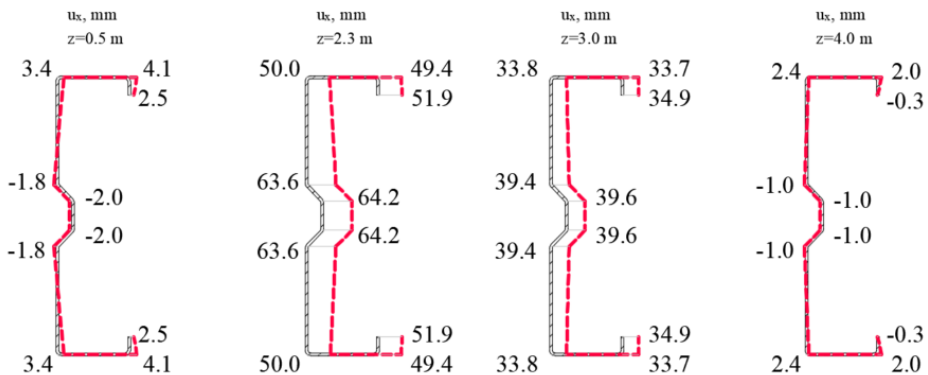

**Fig. 9.** Displacements in element sections without material strengthening

The stress diagrams for an element with material hardening in the section are shown in Fig. 10. All the elements of the section work in the elastic zone. The maximum compressive stresses in the section at a distance of 2.3 m from the support are 433 MPa.

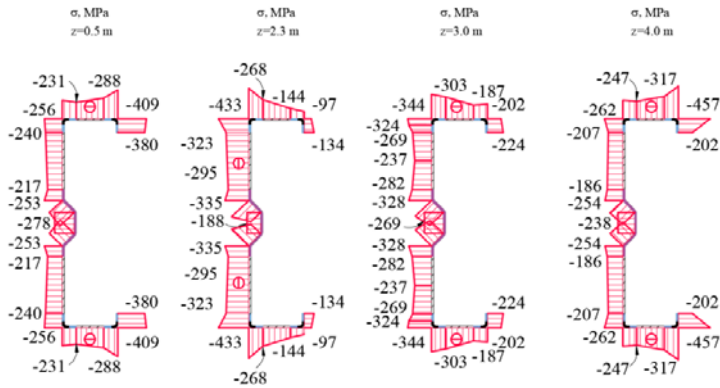

**Fig. 10.** Stresses in reinforced profile sections

The maximum displacements in the lowest stiffness plane - along the x-axis - was 17.1 mm (Fig. 11).

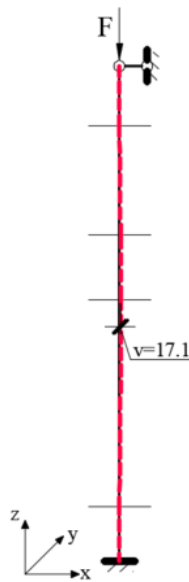

**Fig. 11.** Displacements in a reinforced element

Cross-sectional displacements are shown in Fig. 12.



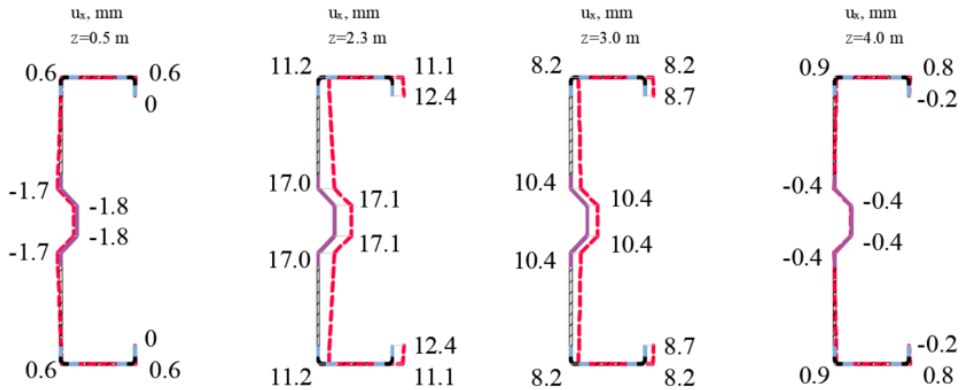

**Fig. 12.** Displacements in cross-sections of a material-strengthened element

## 4 Discussion and conclusions

As a result of this numerical experiment, it can be concluded that the critical operation of the element, taking steel hardening into account, comes later. The rod behaves more steadily and the maximum failure values are reduced by more than a factor of three. This can be explained by the higher stiffness of the material at the cold work hardening points. The steel hardening zones in the thin-walled section model can be used to identify reserves of compressive strength. At the same time, it should be clarified that, at tensile stresses, the effect of work hardening has an unfavourable effect.

## Reference

1. S.J. Britvec, A. Chajes, K.W. Karren, J. Uribe, G. Winter, Effects of cold work in cold-formed steel structural members (1970)
2. K. W. Karren, G.Winter, Fourth progress report on investigation of effects of cold forming on mechanical properties (1964)
3. A.G. Kozlov, Construction in the regions of Eastern Siberia and the Far North: Proceedings of Krasnoyarsk PROMSTRONIIPROEKT **39**, 43-52 (1976)
4. V.M. Derenkovsky, Issues of strength and plasticity. Statics and dynamics of deformable systems **62**, 107-111 (1982)
5. 4. V.M. Derenkovsky, Development of calculation methods and study of the actual work of building metal structures: Collection of scientific papers of the Central Research Institute Proektstalkonstruksiya named after Melnikov, 32-37 (1983)
6. G.A. Arktikov, V.F. Belyaev, L.I. Gladstein, Industrial and civil engineering **5**, 16-24 (1994)
7. I.V. Astakhov, G.I. Belyi, Installation and special construction work **9**, 21-25 (2006)
8. B. Young, J. Yan, Finite Elem. Anal. Des **38**, 549-566 (2002)
9. J. Ye, S. M. Mojtabaei, I. Hajirasouliha, Journal of Constructional Steel Research **144**, 106-118 (2018)
10. N.D. Korsun, D.A. Prostakishina, The Eurasian Scientific Journal, [online] **6(12)**, Available at:<https://esj.today/PDF/63SAVN620.pdf> (2020)