

Application of oil and dye flow visualization in incompressible turbomachinery flows

Alexandros Terzis^{1*}, Pavlos K. Zachos^{2†}, Bernard A. Charnley^{2‡}, and Anestis I. Kalfas^{3§}

¹Ecole Polytechnique Fédérale de Lausanne, EPFL-STI-IGM-LTT, CH-1015, Lausanne, Switzerland

²Cranfield University, Department of Power and Propulsion, MK43 0AL, Bedfordshire, United Kingdom

³AUTH, Department of Mechanical Engineering, 54124 Thessaloniki, Greece

Abstract. Flow visualization is one of many available tools in experimental fluid mechanics and is used from the primary stages of fluid mechanics research in order to identify the physical sizes and locations of the flow features under consideration. Most of the fluids used in engineering applications are transparent (water, air, etc) and flow visualization techniques are used in order to make their flow patterns visible. Simple flow visualization experiments are relatively inexpensive and they can be easily implemented providing with a first feeling of the characteristics of the flow domain. Subsequently, flow visualization techniques are of great applicability in complex flow fields and especially in turbomachinery applications where the flow is characterized by three dimensional and secondary flow patterns. In general, fluid motion can be visualized by surface flow visualization, by particle tracer methods or by optical methods. The former flow visualization technique reveals the streamlines of fluid flows around a solid surface. In this paper flow visualization techniques applied in two different cases of experimental testing (fans in crossflow and cascade experiment) are presented. In both cases, the mixture of paint was prepared using a highly volatile light mineral or heavy machine oil of viscosities of approximately *100cP* and *200cP*, respectively, together with very fine pigments of Titanium Dioxide (TiO₂) or fluorescein sodium in various colors. After the preparation of the mixture, a homogenous thin film was applied onto the whole plate surface by painting it with a soft brush. The air stream which flows over the surface of the plate, modifies the concentration and the homogeneity of the oil film, according to the flow conditions very close to the wall. The film was dried by the airflow and photographed for further consideration while the time taken for drying depended on the wind tunnel velocity as well as, on the pigmentation of the mixture. Successful and un-successful flow visualization tests are herein presented while each case is respectively commented as far as the mixtures, the proportions used and the application onto the rigs are concerned.

1 Introduction

Flow visualization is one of many available tools in experimental fluid mechanics and it is used from the primary stages of fluid mechanics research in order to identify the physical sizes and locations of the flow features under consideration. Most of the fluids used in mechanical engineering applications are transparent (water, air, etc) and flow visualization techniques are used in order to make their flow patterns visible. The basic idea involved in any flow visualization method is that a small quantity of an additive substance (visible) can be distinguished from the main flow (invisible). Reviews of the flow visualization techniques can be found in the studies of Merzkirch (1987) [11]; Smits and Lim 2000 [15] while some modern trends on flow visualization have been presented by Fujisawa, Verhoeckx et al. 2007 [2]. On the other hand, application of the high fidelity computational fluid dynamics (CFD) methods that can be used nowadays, may supply some interesting flow patterns [7,19], but these solutions may not correspond to

natural situations unless validated against experimental data.

Simple flow visualization experiments are relatively inexpensive and they can be easily implemented providing with a first feeling of the characteristics of the flow domain. Subsequently, flow visualization techniques are of great applicability in complex flow fields, such as jets in crossflow [6,17,18] and turbomachinery applications where the flow is characterized by three dimensional and secondary flow patterns. In the larger category of direct injection methods, fluid motion can be visualized by surface flow visualization, by particle tracer methods or by optical methods. The former visualization technique reveals the streamlines of a fluid which flows over a solid region by making use of a sprayable or painted coating on the examined surface. The interaction between the coating and the main flow can be mechanical, chemical or thermal, providing information for the wall pressure, skin friction or simply flow direction as well as the mass transfer to the wall or the heat transfer rate or temperature.

This paper deals with the surface flow visualization technique and particular with surface oil flow

* Alexandros Terzis: aterzis@technion.ac.il

† Pavlos K. Zachos: p.zachos@cranfield.ac.uk

‡ Bernard A. Charnley: b.a.chnley@cranfield.ac.uk

§ Anestis I. Kalfas: akalfas@auth.gr

visualization (SOFV) method which finds great applicability in wind tunnel testing [1,9]. However, surface flow visualization methods involves several forms and mixtures such as visualizing tufts or china clay [12] which is often used in order to identify the laminar from the turbulent regions of boundary layer. Recent reviews and discussions on SOFV methods presented in the studies of Lu 2010 [8]; Pierce and Lu et al. 2010 [13]. SOFV is a very popular method for troubleshooting poor flow behavior and it has been used for more than 50 years in aerodynamic research. This visualization technique involves a paint mixture, usually consisted of oil and dye and it has been used by a number of authors in low [3,10] or high speed experiments [5,14,16] due to the advantages of easy implementation and inexpensiveness. Dye is constituted by very fine pigments of Titanium Dioxide (TiO_2) or fluorescein sodium in various colors. Oil and dye paint mixtures is used to visualize a variety of interesting issues in fluid mechanics research, from simple detections of flow direction and stagnation points to investigation of transitional characteristics on turbomachinery blades [4]. Moreover, different dye colors can provide information about the mixing due to the interaction of two fluids while another interesting application of this method is the detection of critical points, eliminating mistakes in the design phases.

This paper is consisted of two different parts. Firstly, the oil and dye surface flow visualization technique was used in order to visualize the flow patterns around and behind a single fan in crossflow focusing on the optimization of the lateral pitching distance of a cascade of fans inside a low-speed wind tunnel. Secondly, the wake profile of a compressor cascade was visualized evaluating the performance of the recently designed low-speed wind tunnel plenum chamber where it was mounted and focusing on the optimization of the plenum design. The main objective of this study is to discuss the oil and dye flow visualization characteristics and the applicability of this method from low-speed testing to marginally compressible flow experiments ($Ma=0.25$). Particular attention is given in the preparation of the paint mixture due to the difficulty to come up with straightforward suggestions and instructions.

2 Mixture preparation and procedure

2.1 General procedure

The flow visualization experiments employed in the present study, aimed to make the flow path lines visible by the addition of a tracer in the flow. The tracer in this case was a paint mixture consisted of oil and dye in particular proportions in order to visualize the desirable surfaces. The mixture of paint was prepared using a highly volatile light mineral or heavy machine oil of known viscosity together with very fine pigments of Titanium Dioxide (TiO_2) ($\rho=4.23g/cm^3$) or fluorescein sodium in various colors. After the preparation of the mixture, a homogenous thin film was applied onto the whole plate surface by painting it with a soft brush. It should be

noticed that the oil and dye mixture must cover the whole plate surface, homogeneously, for better experimental quality, allowing the comparison with the unaffected areas of the solid surface. The air stream which flows over the surface of the plate, modifies the concentration and the homogeneity of the oil film, according to the flow conditions very close to the wall. The oil is carried away with the air stream and the dry pigment remains on the surface where it forms a streaky pattern indicating the direction of the flow. The dried film was then photographed for further consideration while the time taken for drying depended on the wind tunnel velocity as well as, on the pigmentation of the mixture.

2.2 Which is the ideal recipe?

Although there are many instructions in the literature illustrating how to prepare a paint mixture, a large amount of practical experience is collected and described in unpublished laboratory reports or manuals. Maltby and Keating (1962) [10] stated the difficulty to come up with straightforward suggestions regarding the ideal proportions of oil and dye in the final mixture. The authors agree with the above statement and force the reader to have always in mind that the most appropriate flow visualization recipe is usually chosen using several trials on the mixture consistency.

The main challenge for the researcher is to prepare a mixture with such a consistency that it will run easily under the desirable test conditions. In general the amount of Titanium Dioxide (TiO_2) in the final mixture is very small. In the experiments of Kalfas (1994) [4], the concentration of solid pigments in the final mixture was typically varied from $0.1g/cm^3$ to $0.3g/cm^3$, for a velocity range between $5m/s$ and $35m/s$. Ideally, the mixture should not begin to run until the required wind velocity is reached and after an appropriate time of running, the pattern should be insufficient dry to in order to be unaffected by the unsteady air flow due to the stop of the wind tunnel. As a result, wind tunnels with slow fan motor acceleration are not recommended for oil and dye flow visualization. The time required for a surfaces flow pattern to be established is reduced by increasing wind tunnel velocity and reducing the viscosity of the paint mixture. According to the experience of authors the duration of a successful experiment should be in the order of $15sec$. Moreover, the lower is the required air velocity; the lower should be the viscosity of the final mixture. The authors observed that when the airflow velocity is lower than $7-8 m/s$, the oil and dye mixture should be diluted using alcohol, in order to achieve further viscosity reduction. Liquids that have been used in the past as solvents of paint mixtures are, in ascending viscosity: alcohol, kerosene, light Diesel oil and light transformer oil. On the other hand, visualization of high speed flows, but still incompressible ($M=0.15$), does not require viscosity reduction and in some cases heavy (engine or machine) oil is used to visualize such a domain.

For a successful flow visualization experiment, the properties of the mixture applied onto the examined surface should be chosen in a way that the complete

painted area is covered after the test with fine structures or ligaments. In general, the most appropriate oil and dye flow visualization recipe is usually chosen using several trials on the mixture consistency, while the viscosity of the paint mixture should be chosen in a way that the duration of the experiment does not exceed 15-20sec.

2.3 Mixture concentrations used in this study

In the first case study of this paper, the visualization of a single fan in crossflow was made by a paint mixture prepared by making use of machine light oil of density, $\rho=0.8g/cm^3$ and viscosity of 100cP, together with very fine pigments of fluorescein sodium in yellow and red colors. In these series of experiments, a small amount of fluorescein sodium was mixed with light oil until a uniform, lump free paste was formed. In the majority of the cases considered, the concentration of solid pigments in the final mixture was approximately, 0.05g/cm³ and kept constant for a wind tunnel velocity range between 6m/s and 12m/s. Note that due to the very low velocities behind the jet (fan), a small amount of paint mixture was diluted by the addition of white spirit drops (90cP) until the achievement of the desirable mixture viscosity. However, attention has to be paid in the mixing between when using both solvents in order to avoid mixture separation during the experiment (see later discussion).

In the second case study, the flow visualization technique was employed to verify the functionality of a new plenum chamber design used to accommodate the wake downstream a compressor cascade at high incidence. However, due to the higher velocities developed in the test rig, a completely different viscosity of the paint mixture was applied. The light machine oil was unable to resist the momentum of the surface flow and subsequently the pigmentation was not visible for further consideration since it was washed away by the main flow. For this reason, a heavy engine oil of viscosity of 200cP was used in order to compensate at this high velocity level (35m/s to 45m/s). Note that due to the relatively dark color of the heavy oil, the amount of fluorescein sodium particles was doubled compared to the former paint mixture in order to increase the brightness of the surface and allow further analysis.

Finally, it should be noticed that better picture quality of the paint surface is achieved when there is no natural light in the test section. Normally, the painted surface is illuminated by a soft, uniform black (UV) light, which emits very little visible light. This helps to keep the amount of pigments used in the mixture as low as possible and thereby to reduce the disturbance of the flow.

2.3 Results and discussion case 1: Single fan in crossflow (low speed incompressible flow, 5-15 m/s)

The flow visualization experiments employed in the first, low speed and incompressible test case of a single fan in crossflow, aimed to make the flow path lines visible by the addition of oil and dye mixture in the flow. The main objective of this experimental approach is to optimize the

lateral pitching distance of a cascade of fans allowing further investigation of swirl jets in crossflow [18]. A clear view of the vortical structures located close to the wall, has been obtained, including the horseshoe vortex, the counter rotating vortices (hanging vortices) and the wake vortices downstream of the injection hole. These vortical structures, visualized using various combinations of mixture paints and different test conditions. The velocity ratio, which is defined as the ratio of the axial velocity of the fan to the freestream velocity was defined by adjusting speed of the wind tunnel in order to achieve the desirable velocity ratios of 0.75 and 1.0.

Fig.1 indicates the surface flow visualization at the near wake of a single fan in crossflow. It is easy to observe the different vortex size appeared due to the different velocity ratio. As the momentum of the jet increases, compared with that of the crossflow, the size of the vortices at the trailing edge also increases. The jet penetrates further into the crossflow at higher velocity ratios and subsequently, creates a bigger obstacle to the main flow. These "hanging" vortices at the wake for the injection hole are the beginning of the counter rotating vortex pair (CVP). This contra rotating vortices during the lift-off of the jet, due to the shear stress interaction with the main stream, entrain fluid from the crossflow into the jet. This transformation of crossflow fluid to the blade surface, is proportional to the intensity of the rotating vortex and subsequently the larger vortices (larger velocity ratio), the more fluid of the main stream close to the wall.

In addition, the flow visualization experiments indicate that the hanging vortices are not symmetrical to the axial centerline but slightly shifted in the direction of the rotation of the blades. According to a previous work of the authors [18] swirl velocity of the jet, introduces a general asymmetry on the flow domain as well as a small bias of the jet trace. Therefore, the jet not only bends in the direction of the main stream but also diverts in the direction of the momentum in order to conserve its angular momentum.

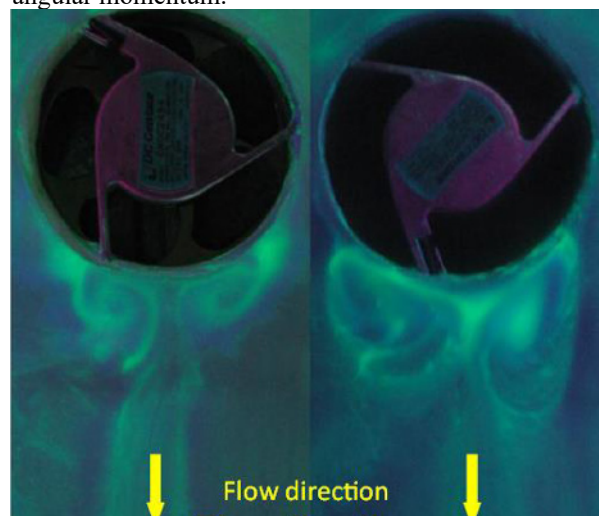

Fig. 1. Hanging Vortices at the trailing edge of the fan for very low viscosity of the paint mixture

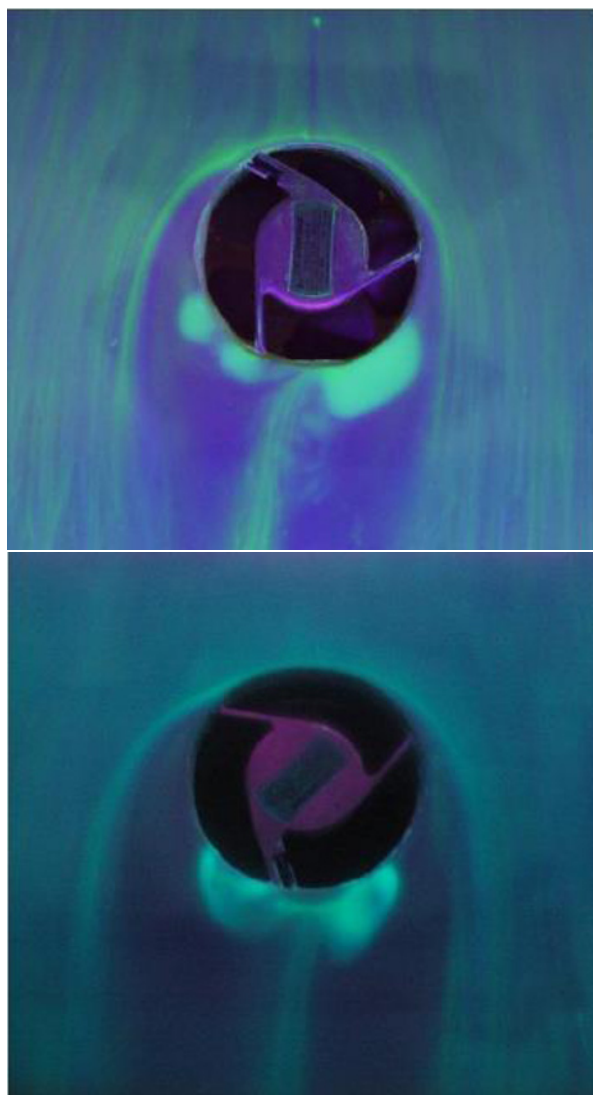

Fig. 2. Flow pattern of a fan in crossflow. Normal viscosity of the paint mixture (no dilution).

Fig.2 indicates pictures of the same flow domain with Fig.1, taken in a different height from the wall surface, 1, in order to give a general feeling of the "footprint" of the flow. The horseshoe is easily observed as well as the wake vortices downstream of the fan. The horseshoe vortex forms close to the wall upstream of the jet, wraps around the jet and reorients itself in the streamwise direction. The flow domain near the wall is similar with the flow over a cylinder. The spreading of the jet is highly affected by the obstacle created in the main flow due to the injection of the jet. Obviously, the higher velocity ratio, the bigger obstacle is encountered in the mainstream and therefore, a broader footprint of the flow pattern (see Fig. 2 right). In addition, the wake vortices indicate the jet trace at further downstream distances. Due to the rotation of the fan, a small diversion of the jet can be observed as the jet fluid travels downstream of the injection hole. The bias of the jet trace has been observed also by [20] who performed some flow visualization experiments of a swirling jet in crossflow in a water tunnel.

Case 2: Wake of compressor cascade (high speed incompressible flow, 35-50 m/s)

In the second case study, the flow visualization technique was employed to verify the functionality of a new plenum chamber design used to accommodate the wake downstream a compressor cascade at high incidence. In case of far off-design blade operation (that is for incidence angles higher than -50°C) the flow in the channels is totally separated and this results in a highly unsteady flow pattern throughout the blade channel which propagates also downstream. In that case, extra care must be taken for the design of the plenum chamber of such a facility, as the interaction of the unsteady wakes with the also unsteady effects that the side-vortices shed by the first and the last blade should be kept to a minimum. This allows the study of the wake unsteadiness alone without any effect of the side vortices, which will affect significantly the flow patterns leading to inaccurate blade performance measurement results. Ideally, the plenum chamber should be able to isolate and contain the side vortices and this is what the above described flow visualization technique can identify.

During the development phase of the rig (whose layout is presented in Fig. 3), two main flow visualization test sets carried out; without the blades mounted and with all the blades in place. As shown in the top left side of Fig. 4, in case there are no blades mounted in the rig a single vortex can be observed at the right side of the plenum chamber. A couple of stagnation zones separate the main flow path (that is the stream that leaves the blade channels) from the side wall flow patterns that stay isolated at the right corner. A second, contra-rotating vortex is developed when all the blades are mounted in the test section (see Fig. 4 top right). Due to the presence of the compressor blades, the side wall driven flow region is slightly extended than the previous one with only one stagnation zone this time. In this case, it was found that the blades located closer to this flow area experience a 10-15% lower static pressure than the rest. In other words an undesirable static pressure gradient in the pitch-wise direction downstream of the blades existed. Therefore, a new version of side wall design was triggered by the two first flow visualization tests, with the ambition to eliminate even more the side wall effects and create a uniform static pressure flowfield since it was found that the blades mounted closer to them had an interference with the side vortices of the plenum. The new plenum design is shown in Fig. 4 bottom left. However, the new version of the chamber was no better than the first one as stronger interaction between the blades and the side phenomena was observed. The stream lines of the flow with the revised plenum design are presented in Fig. 4 bottom right. Consequently, the early version of the rig was finally preferred to conduct the experiments. All the final tests were conducted in the middle blade passage to avoid any interaction of the blade flows with the side wall secondary flow patterns.

In this case, due to the higher velocities developed in the test rig, a completely different viscosity of the paint mixture was applied. The mineral oil was unable to resist the momentum of the surface flow and subsequently the

pigmentation was not visible for further consideration. For this reason, engine oil (60-70W) was used at very high velocities. Due to the dark color of the heavy oil, the amount of fluorescein sodium particles was slightly increased compared to the initial paint mixture in order to increase the brightness of the surface and allow further analysis.

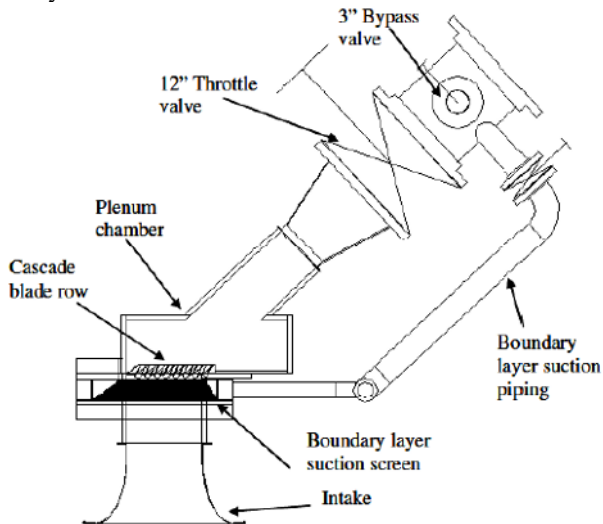

Fig. 3. Layout of the experimental facility

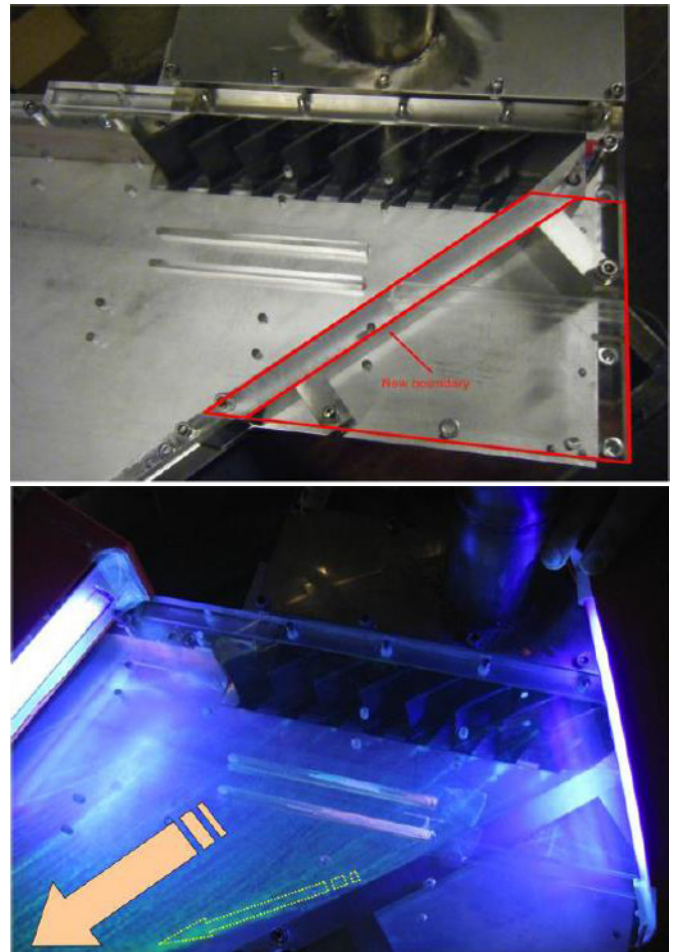

Fig. 4. Flow patterns within the plenum the chamber of the rig with no blades mounded (first), with all the blades in place (second). Mew plenum design (third) and stream lines with the new plenum design (fourth)

2.4 Examples of “unsuccessful” experiments and tips

First of all it should be noted that the amount of TiO_2 or fluorescein sodium in the final mixture, as well as the main paint mixture (including oil) should be small enough and restricted only to a film layer, in order to allow the fluid particles to follow their traces. In addition, differences between the properties of the paint mixture and the air of the tunnel are critical to the successful visual representation of the flow. For example, large differences in density between the paint mixture and the air of the tunnel may lead to some gravitational effects and the pigmentation is not able to follow the real flow pattern. This section deals with “unsuccessful” experiments, illustrating how roughcast mixture preparation affects the outcome of the experiment. However, it should be noticed that the success of any flow visualization experiment depends on the researcher and the desirable quality and clarity of the pictures.

As discussed earlier, the lower air velocity the lower should be the viscosity of the paint mixture and this reduction is achieved using a number of solvents (alcohol, white spirit, kerosene etc). However, particular attention has to be paid in the mixing between the paint mixture and

the solvent. Non proper mixing may lead to dissociation between the white spirit and the paint mixture (oil and dye) during the execution of the experiment, resulting in the creation of undesirable “waves” or “bubbles” on the target surface, which reduces the quality of the picture and does not allow the further consideration of the footprint. In some cases this kind of dissociation can be observed even before the execution of the experiment, as shown in Fig. 5. Fig. 6 indicates the aforementioned situation and illustrates the bubbles created in the surface as generated after the execution. For better comparison with proper mixtures, the pictures in Fig. 6 are cut in the centerline. The flowing oil film may become unstable, break up and form droplets which due to the large resistance shot at high speed across the oil film and therefore produce some striations as shown in Fig.7 left. Many authors in the past observed some longitudinal instability in the thin oil film. On the other hand, the use of heavy oil may result in accumulation at swirling or low speed regions, which may smear during the shutdown of the wind tunnel. Fig. 7 right indicates that the vortical structures at the wake of the single fan are not visible with the wind tunnel turned off.

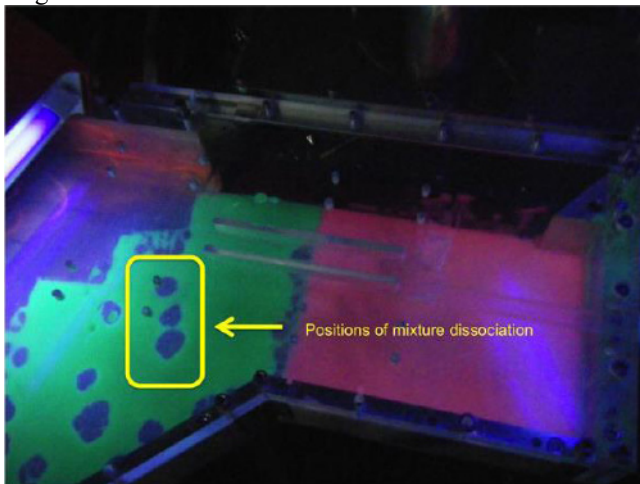

Fig. 5. Mixture dissociation observed before the execution of the cascade experiment (top view of the rig)

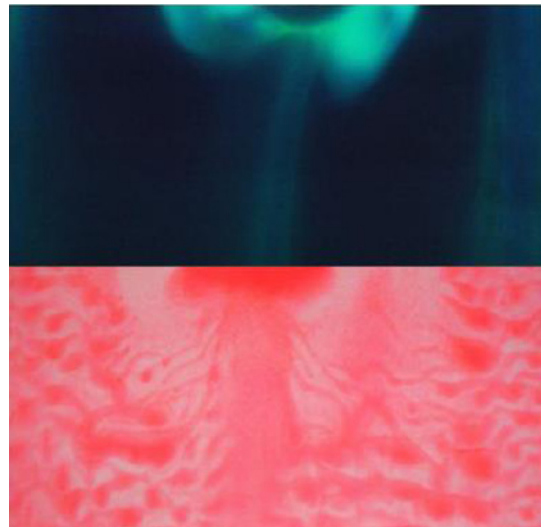
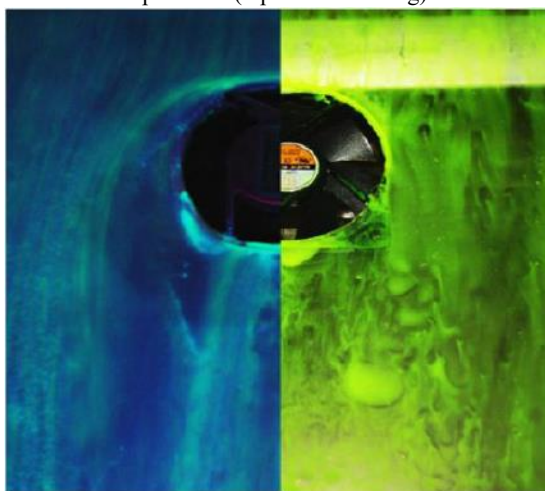

Fig. 6. Proper and roughcast paint mixture and the effect of UV light on picture quality a) waves and b) bubbles at the wake of the fan, due to separation between white spirit and mixture.

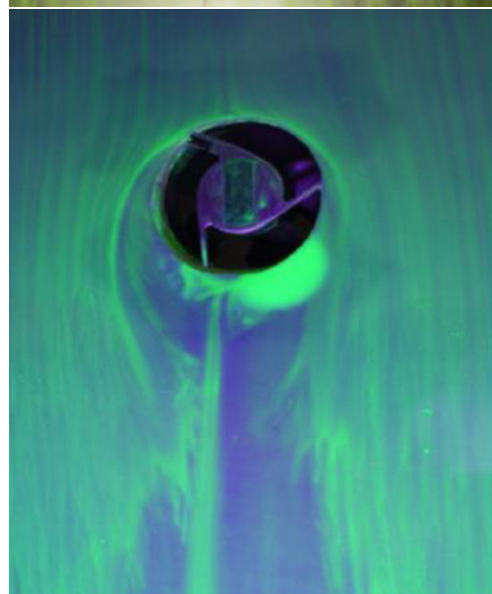
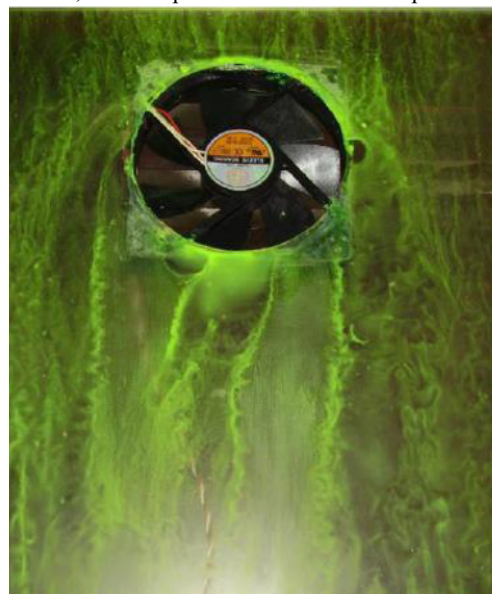

Fig. 7. Striations on the flow surface and smear of the mixture during the shutdown of the experiment

3 Conclusions

In this investigation the main characteristics of oil and dye flow visualization from very low velocities to marginally incompressible flows are discussed. Particular attention is given to the paint mixture and the general procedure due to the limit amount of investigations providing particular proper and roughcast recipes. The first part of this paper deals with the visualization of a single fan in crossflow and the second part of this work focuses on the representation of the wake of a compressor cascade. In both cases, the mixture of paint was prepared using a highly volatile light mineral or heavy machine oil of viscosities of approximately *100cP* and *200cP*, respectively, together with very fine pigments of Titanium Dioxide (TiO₂) or fluorescein sodium in various colors. The paint mixture was diluted with white spirit or alcohol when appropriate. The findings of this investigation can be summarized as follows:

1. The most appropriate flow visualization recipe is usually chosen using several trials on the mixture consistency and usually depends on the desirable picture quality.
2. The duration of a successful experiment should be in the order of *15sec*.
3. When the airflow velocity is lower than *7 m/s*, the oil and dye mixture should be diluted using alcohol or white spirit, in order to achieve further viscosity reduction and better quality of the footprint.
4. *Waves* or *bubbles* on the visualization surface can be avoided by better mixing between the paint mixture and the solvent used for viscosity reduction.
5. When the air speed exceeds the number of *30-35 m/s*, the viscosity of the light machine oil (*100cP*) is not appropriate to for an acceptable visualization of the flow pattern since most of the mixture was unable to resist the momentum of the surface flow and subsequently the pigmentation was not visible for further consideration. For this reason, engine oil (*60-70W*) was used at very high velocities.
6. The disadvantage of the dark color produced by engine oils can be overcome by increasing the amount of fluorescein sodium particles in the final mixture.

4 Acknowledgments

The authors would like to acknowledge the support of the doctoral researcher Panagiotis (Panos) Giannakakis from Cranfield University during the cascade tests and for his overall support and help over the last two years.

References

1. J. B. Barlow, W. H. Rae, et al., *Low Speed Wind Tunnel Testing*, 3rd Edition, John Wiley and Sons Inc, USA (1999).
2. N. Fujisawa, M. Verhoeckx, et al., *Recent Progress in Flow Visualization Techniques toward the Generation of Fluid Art*, *J. Vis.* **10**(2), pp. 163-170 (2007).
3. A. R. George, *Aerodynamic Effects of Shape, Camber, Pitch and Ground Proximity on Idealized Ground-Vehicle Bodies*, *J. Fluids Eng.* **103**, pp. 631-638 (1981).
4. A. I. Kalfas, *Transition to Turbulence in the Boundary Layer of Turbomachinery Blades*, PhD Thesis, Cranfield University, United Kingdom (1994).
5. E. R. Keener, *Oil Flow Separation Patterns on an Ogive Forebody*, *AIAA J.* **21**, pp. 550-556 (1983).
6. R. M. Kelso, A. J. Smits, *Horseshoe Vortex Systems Resulting from the Interaction Between a Laminar Boundary Layer and a Transverse Jet*, *Phys. Fluids* **7**(1), pp. 153-158 (1995).
7. D. N. Kenwright, C. Henze, et al. *Feature Extraction of Separation and Attachment Lines*, *IEEE Trans. Vis. Comput. Graph.* **5**(2), pp. 135-144 (1999).
8. F. K. Lu, *Surface Oil Flow Visualization*, *Eur. Phys. J.* **182**, pp. 51-63 (2010).
9. R. L. Maltby, *Flow Visualization in Wind Tunnels Using Indicators*, AGARD-70 (1962).
10. R. L. Maltby, R. F. A. Keating, *The Surface Oil Flow Technique for Use in Low Speed Wind Tunnels*, In AGARD-70, pp. 29-38 (1962).
11. W. Merzkirch, *Techniques of Flow Visualization*, AGARD-AG-302 (1987).
12. I. R. M. Moir, *Research Experience in the RAE 5 Metre Wind Tunnel of a China Clay Method for Indicating Boundary Layer Transition*, *Aeronaut. J.*, Paper No. 1391 (1986).
13. A. J. Pierce, F. K. Lu, et al., *New Developments in Surface Oil Flow Visualization*, 27th AIAA Aerodynamic Measurement Technology and Ground Testing Conference 28 June - 1 July, Chicago, Illinois (2010).
14. J. P. Reding, L. E. Ericsson, *Flow Visualization Reveals Causes of Shuttle Non-Linear Aerodynamics*, *J. Aircr.* **19**, pp. 928-933 (1982).
15. A. J. Smits, T. T. Lim, *Flow Visualization: Techniques and Examples*, Imperial College Press, London, UK (2000).
16. A. Stanbrook, *The Surface Oil Flow Technique for Use in High Speed Wind Tunnels*, In AGARD-70, pp. 39-49 (1962).
17. A. Terzis, *Flow Visualization and Performance of Fans in Crossflow*, Dipl. Ing. Thesis, Aristotle University of Thessaloniki, Greece (2008).

18. A. Terzis, C. Kazakos, et al., *Effects of the Swirl Velocity of a Jet in Crossflow from Fan Assemblies Mounted on Lifting Surfaces*, ASME-Turbo Expo, GT2010-23357, 14-18 June, Glasgow, Scotland (2010).
19. S. D. Venkata, M. Jiang, et al., *Automated Detection of Vortex Cores and Separated Flows in CFD Datasheets*, Proceedings of the 8th International Conference on Numerical Grid Generation in Computational Field Simulations, Honolulu, Hawaii: 529-538 (2002).
20. T. Yingjaroen, A. Pimpin, et al., *Evolution of Mixing Regions in Jet and Swirling Jet in Crossflow: An Experimental Study*, The 20th Conference of Mechanical Engineering Network of Thailand. 18-20 Oct., Nakhon Ratcasima (2006).