

# Development of the snowmelt prediction model using Artificial Intelligence (AI)

## *Développement d'un modèle de prévision de la fonte des neiges à l'aide de l'intelligence artificielle (IA)*

Masami Abe<sup>1</sup>, Hiroki Takiguchi<sup>1\*</sup>, and Yoshihisa Hida<sup>1</sup>

<sup>1</sup>AI Promotion Office, IDEA Consultants, Inc., 3-15-1 Komazawa, Setagaya-ku, Tokyo 154-8585, Japan

**Abstract.** Droughts and abnormal heavy rains have frequently occurred in Japan due to the effects of climate change in recent years, and flexible operations that maximize the functions of dams are required. Especially in cold snowy regions, snowmelt water is stored in a dam to cover water demand from early spring to early summer, but during the snowmelt season, a sudden rise in temperature and heavy rain could cause large-scale floods. Therefore, the highly accurate prediction of dam inflow during the snowmelt season is extremely important from the viewpoint of effective use of water resources and prevention of snowmelt floods. On the other hand, in recent years, research utilizing Artificial Intelligence (AI) has also been promoted in the hydrological field. This study clarified the problems of the conventional physical model (rainfall runoff model) and the prediction model by AI for the inflow of the dam during the snowmelt season in order to support efficient dam management. Then, by constructing a semi-physical model that complements the problems of the physical model and the AI model, we developed a more accurate model for predicting the inflow of snowmelt water during the snowmelt season compared to the single model.

**Résumé.** Ces dernières années, le Japon a connu de fréquentes sécheresses et pluies torrentielles dues aux effets du changement climatique ; d'où l'importance d'une gestion souple exploitant au maximum les fonctions des barrages, en particulier dans les régions froides et enneigées où l'eau issue de la fonte des neiges est stockée dans des barrages pour couvrir les besoins hydriques du début du printemps aux premiers jours d'été. En effet, un brusque redoux et de fortes pluies peuvent entraîner des crues majeures au moment de la fonte. Du point de vue de la valorisation des ressources en eau et de la prévention des

---

\* Corresponding author: [takiguchi@ideacon.co.jp](mailto:takiguchi@ideacon.co.jp)

inondations, il est ainsi essentiel de prévoir avec une grande précision la quantité d'eau arrivant dans les barrages pendant cette période. Or, dans le domaine de l'hydrologie aussi, les recherches récentes mettent à profit l'Intelligence Artificielle (IA). Cette étude, qui vise à favoriser une gestion plus efficace des barrages, a mis en évidence les limites du modèle physique traditionnel (ruissellement des eaux de pluie) et du modèle de l'IA pour ce type de prédiction. En construisant un modèle semi-physique capable de pallier les insuffisances de ces deux modèles, nous avons développé un modèle prédictif plus précis que chacun de ces modèles isolés.

## 1 Introduction

The regions of Ishikari, Sorachi, and Kamikawa of Hokkaido, Japan (Figure 1.), which are home to rivers such as the Ishikari and the Teshio as well as the Jozankei Dam, have topographical characteristics that bring the regions some of the highest snowfall in Hokkaido. These rivers serve as an important source of water for agricultural and other uses from spring to summer. Dam inflow during the snowmelt season is affected by the temperatures, solar radiation, and precipitation. After infiltrating into and being stored in the deposited snow and the ground, snowmelt water runs into rivers. It reaches a dam after a lapse of time which corresponds to the length of the main stream. As a result of such a snowmelt event, the dam inflow is characterized by diurnal variations in the absence of precipitation, while it increases at a level greater than the amount of precipitation when it rains. It is important to have 6-hour inflow prediction for flood control, or 72-hour prediction when taking time-delay phenomenon into account.

As a means to make predictions about the series of occurrences from snowmelt events to dam inflow, a physical model that combines a model to calculate snowmelt (heat balance method) with a rainfall-runoff model has traditionally been used. The predictive accuracy of this model cannot necessarily be considered great, however, as it involves a number of processes that are not well defined or easy to observe, such as the phenomena of infiltration and storage, as well as uncertain factors such as parameter settings for individual models.

This study aimed to develop an ideal model to predict snowmelt by building, and comparing the predictive accuracy of, different methods including a physical model, AI such as recurrent neural network (RNN) models, and a model that links a physical model with AI. While RNN models were highly effective in making short-term predictions, physical models in some cases produced more accurate predictions a few days ahead. Physical models, however, could be widely off the mark, which indicated possible accuracy issues unless they were linked to other technologies such as data assimilation. An approach to use AI to predict the initial data for a physical model was also explored, from the standpoint of combining the advantages of both a physical model and AI.

## 2 Methods

Models for predicting the inflow of snowmelt water into dam may be divided roughly into two categories: (i) prediction of snowmelt runoff at individual locations and (ii) prediction of dam inflow. In this study, models of each of the two categories were developed. For the latter, a number of different models were developed, including a conventional physical model, one using data on snowmelt runoff, and an AI model that uses meteorological data that are readily available only.

### 2.1 Acquisition of data

The data specifications used in this study are provided in Table 1. For precipitation, information for spatial distribution of a 14 × 17 grid was available since information collected was that of rainfall recorded by the Japan Meteorological Agency for the areas corresponding to the relevant catchment areas (Figure 1.).

The energy balance is the sum of total solar radiation, reflected solar radiation, and radiation.

**Table 1.** Data specifications.

St.	Observation items	Unit
A	Energy balance	W/m <sup>2</sup>
A	Surface temperature	° C
A	Wind velocity	m/s
A	Temperature	° C
A	Humidity	%
A	snow depth	cm
A	snowmelt	mm
B	Dam inflow	m <sup>3</sup> /sec

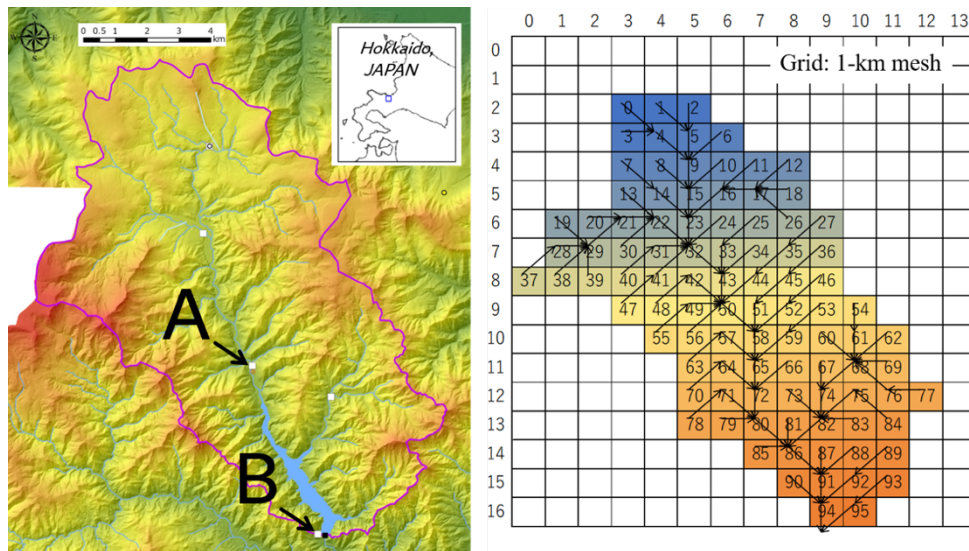

**Fig. 1.** Location maps (Grid: 1-km mesh). Station A and B are observation points. The color indicates altitude.

## 2.2 Development of a model to predict space-time distribution of snowmelt runoff

Data for snowmelt runoff were available in the form of actual measurements taken at driftwood disposal facilities, which is one of the observation stations of the Civil Engineering Research Institute for Cold Region. Other relevant data such as those on snow depth and heat balance were also obtained. These data were used to build a model to predict snowmelt runoff.

### 2.2.1 Characteristics of data on snowmelt runoff

Samples of data for snowmelt runoff and other relevant data from the driftwood disposal facilities are illustrated in Figure 2. Data for precipitation, snowmelt energy, and snowmelt runoff are shown in the form of contour plots with time on the vertical axis for the purpose of visualizing diurnal shifts in time. The snowmelt energy was calculated based on literature [1,2], by using the heat balance to estimate the amount of energy used to melt snow.

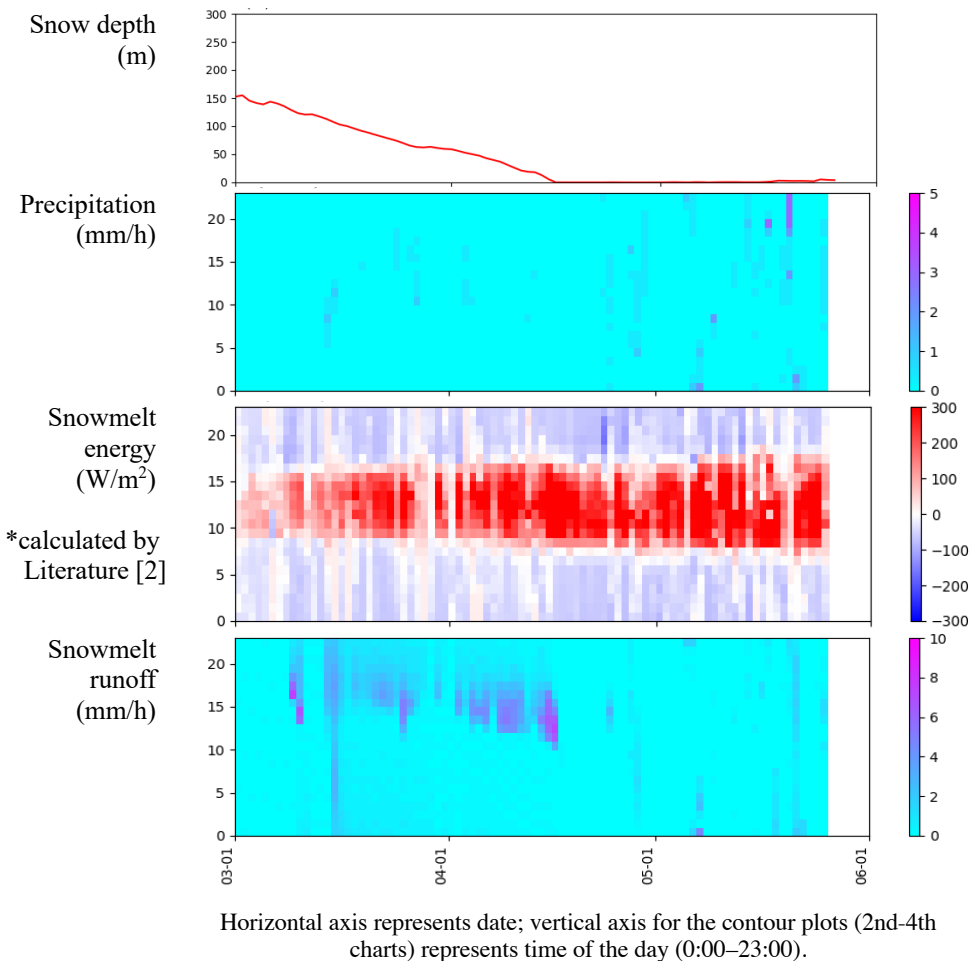

**Fig. 2.** Data on snowmelt runoff (samples).

The smaller the snow depth was, the higher the diurnal snowmelt runoff was. Finally, as the snow depth became zero, so did the snowmelt runoff. It was also shown that there were time delays with the snowmelt energy and snowmelt runoff, with the time delay being smaller as the snow depth became smaller for both the snowmelt energy and snowmelt runoff.

Based on these characteristics, a snowmelt event has been depicted in a simplified manner as shown in Figure 3. for the purpose of modelling. In Phase 1, where the snow depth is great, melting water would travel over a long distance passing through the snowpack before being ultimately observed as a snowmelt volume. This creates a large time delay between the point where snow starts melting (i.e. the snowmelt energy is at its peak) and the point where it is actually observed as runoff. Information on the amount of snowmelt energy alone cannot explain seasonal fluctuations in the rates of snowmelt runoff, either. For this reason, the influences of reductions in the water runoff, such as snowmelt water becoming frozen again over the course of its traveling through a snowpack, were also taken into account in the model, relative to the snow depth. This means that the greater the snow depth is, the lower the snowmelt runoff becomes, relative to the amount of melting water.

On the other hand, in Phase 3, where there is little snowpack remaining, the response of runoff to the start of snow melting becomes quicker due to the effects of solar radiation, etc. However, as the amount of snow, or the source of the runoff is small, the runoff is inevitably limited to low levels.

It is only natural that between Phase 1 and Phase 3 outlined above, there emerges another stage, or Phase 2, where the runoff is the highest. Phase 2 is the stage where the rates of snowmelt runoff are the highest when the snow depth is such that there is an ample amount of snowmelt runoff while the influences of reductions are relatively small.

An outline of the relationship between snow depth and snowmelt runoff, summarized using the actual measurements, demonstrates that the smaller the snow depth is, the higher the snowmelt runoff also is, as shown in the scatter plot (Figure 3., right).

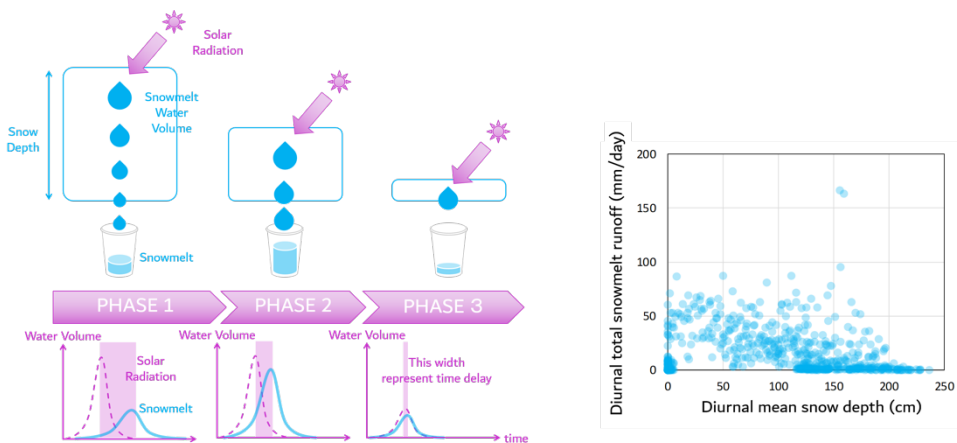
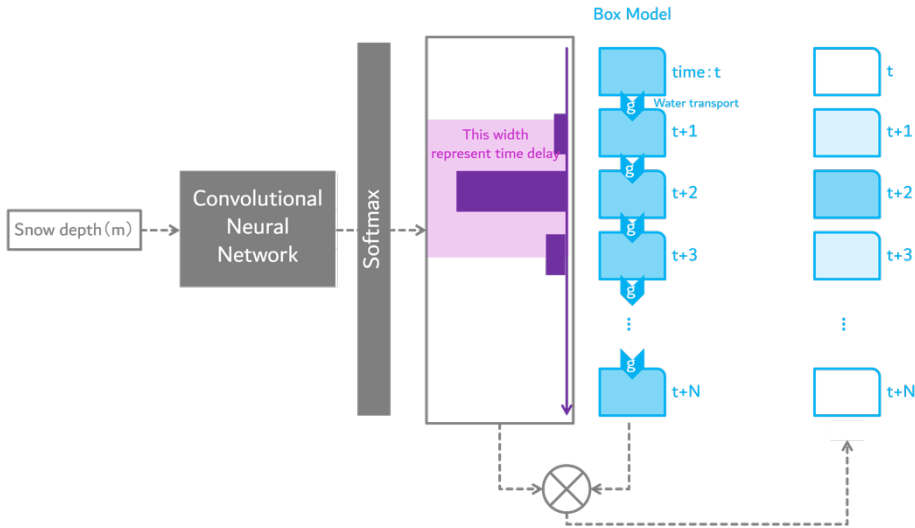

**Fig. 3.** Relationship between measured snow depths (diurnal mean) and snowmelt runoff (diurnal total).

### 2.2.2 Modelling that takes snowmelt events into account

Based on the simplified depiction of snowmelt events shown in Figure 4, a model to predict snowmelt runoff was developed. Since it was possible to make rough estimations of spatial distribution of the snow depth based on data on elevation, etc., spatial distribution of the snowmelt runoff was estimated as well based on the information on the spatial distribution of the snow depth.

Based on literature [1], a box model representing snow accumulation was built with the data for the snowmelt energy (QM) and precipitation used as inputs, and using this, a model that represents time delays was built. This latter model is implemented using TensorFlow, a deep learning library, as a convolution neural network (CNN) that uses mechanisms called Attention. Attention mechanisms serve a role of expressing how large a time delay is expected with which a quantity of melting water is to be counted as a snowmelt runoff, by referring to the actual measurements of snow depth. This allows to present the results of a prediction in a manner that visualizes how large a time delay would be depending on the situation, while maintaining the water balance.



**Fig. 4.** Overview of state space model for predicting snowmelt runoff (Snowmelt Runoff Model).

### 2.3 Prediction of dam inflow

Several potential models for predicting dam inflow were developed using the spatial distribution of snowmelt runoff that was obtained using the model in Section 2.2 above. Issues with the different methods were identified by comparing the predictive accuracy of these models.

#### 2.3.1 Physical model

Firstly, a conventional physical model was built as a baseline. With use of the data on the spatial distribution of snowmelt runoff, a water circulation model of the catchment areas was built. The computational grid is as shown in Figure 2.1. Flow paths were drawn according to elevation, to make a model where snowmelt runoff flows downstream along the flow paths. An overview of the model is provided in Figure 2.5.

Snowmelt runoff model consists of 3 types of models, i) Snowmelt model, ii) Snowpack infiltration model, iii) Runoff model. i) The snowmelt model is based on the heat balance method (Kondo & Yamazaki, 1990 [2]), and taking into account influences of the vegetation. ii) The snowpack infiltration model is based on the single-valued linear function of storage (Nakatsugawa et al, 2004 [3]); Darcy's law was applied to derive the flow of water through a snowpack. iii) The runoff model is based on the two-tank storage function model (Baba et al, 2001 [4]); the runoff process is separated into two components: surface and subsurface

flow and groundwater flow. Data inputs is meteorological observation data from the observation station (Temperature, Snow depth, Precipitation, Sunlight, Solar radiation, Wind speed, Relative humidity).

### 2.3.2 RNN-based models

As a representative example of AI models, a predictive model was built based on the RNN (Long Short-Term Memory (LSTM)) [5], which is suited to representing cumulative effects on a time-series basis.

RNN model was developed: a model to make predictions based solely on meteorological data that are readily available (snow depth, precipitation, and temperatures). An overview of the models is provided in Figure 5.

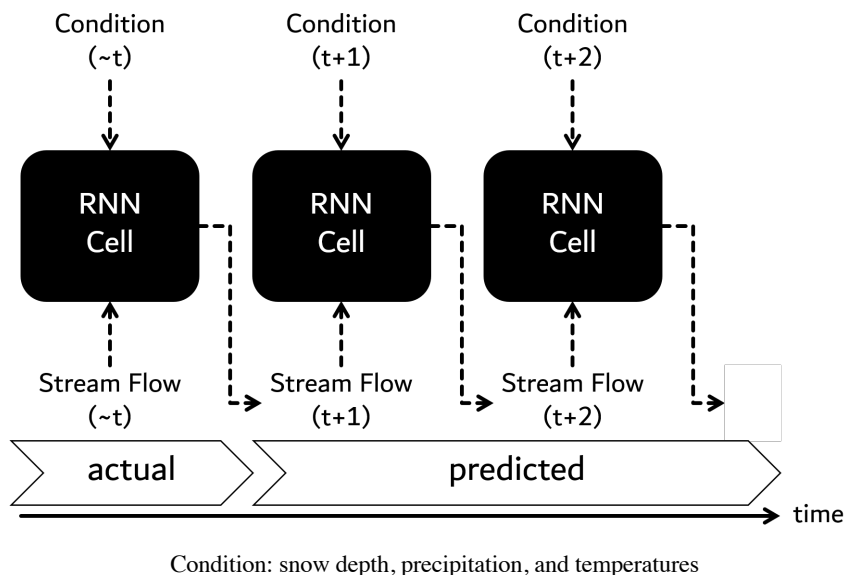

**Fig. 5.** Overview of RNN-based models.

### 2.3.3 Model that utilizes AI to estimate initial values

Physical models behave in a manner that is bound by the laws of physics such as those for water balance and water movement. Therefore, predictions made based on such a model, for a scenario of future global warming for instance, are reliable to a certain degree. Making a prediction by freely incorporating actual measurements of the dam inflow, such as AI-based prediction, on the other hand, is not straightforward, and this requires the use of technologies such as data assimilation.

AI-based prediction is advantageous in that it allows for users to make the most of available data and build a predictive model by freely modifying various elements of its design. An RNN model, for instance, is capable of using the actual dam inflow as the starting point and making a direct prediction of how it will shift from then on; it can make short-term predictions with a very high level of accuracy. On the other hand, its predictive performance is greatly dependent on the data that have been used for its learning, which makes it generally difficult for it to make a prediction of a scenario that has not been covered in the data it used

for learning (e.g. a prediction of the dam inflow in the case of an extreme weather event associated with global warming).

In short, physical models and AI each has their own strong areas. With an aim to take advantage of only the benefits of each type, the authors set out to implement a new physical model capable of launching a prediction based on the current dam inflow, as is the case with an RNN model.

Water levels for individual grids in a physical model are essentially a piece of information on an accumulation of the past water inflows and outflows. Specifically, if one is to obtain the correct calculation for a given time point, it is necessary to perform preconditioning for a certain period of time, and it is not possible to start with a given dam inflow to make a calculation as it would be the case with an RNN model.

Taking this into consideration, a model was developed which used AI to make predictions of the water levels that are stocked in individual grids to achieve a given dam inflow, allowing for computation to be launched at any time point. An overview of the model is provided in Figure 6. If the data on the past dam inflows are available, this model is designed to use AI to predict the initial values for a physical model required for physics calculations using the data for the most recent time point available.

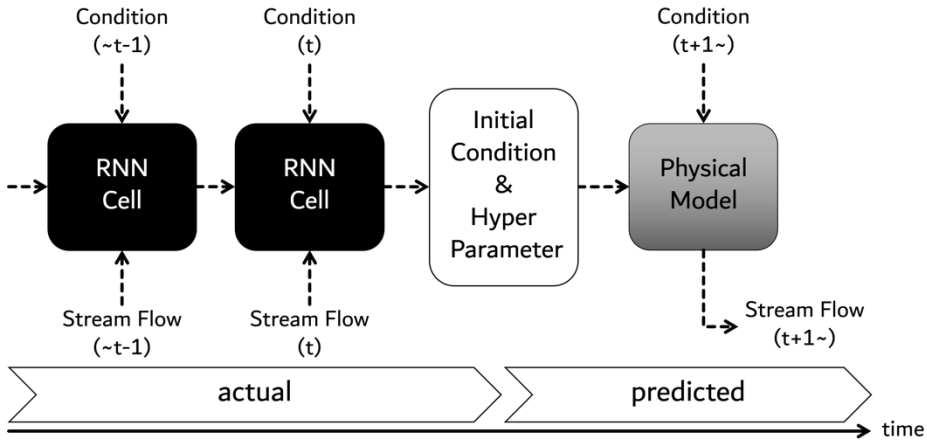

**Fig. 6.** Overview of use of AI for estimation of initial values (Initial Value Setting).

### 3 Results and Discussion

#### 3.1 Demonstration of reproducibility of snowmelt runoff prediction model

Sample predictions of snowmelt runoff made using the snowmelt runoff prediction model are presented in Figure 7. The charts are come in pairs; the top charts show the ranges the predictions could be in, with gray, blue, and pale blue lines each representing the actual measurements, the calculations by the predictive model, and the distribution.

The bottom charts, meanwhile, are color-coded stacked bar charts that show the length of time delay between the point where snow starts melting and the point where it is counted as a snowmelt runoff.

It was demonstration that this model was capable of predicting snowmelt runoff based on the snowmelt energy, precipitation, and snow depth. Using the model, the snowmelt runoff of the whole space was estimated based on the precipitation and snow depth of the whole space.



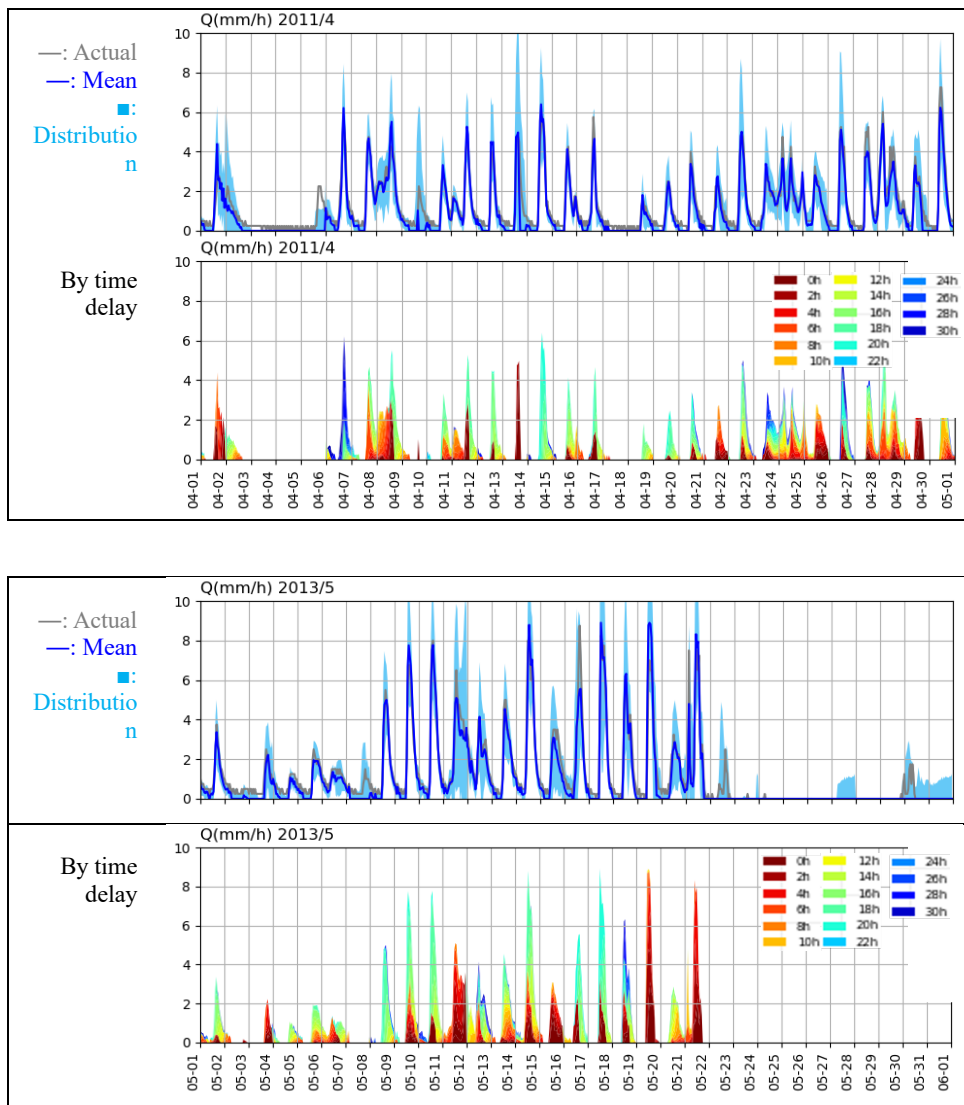

**Fig. 7.** Predictions of snowmelt runoff as shown in Fig. 4.

### 3.2 Comparison of calculations with different dam inflow prediction models

A comparison of the results of validation of the 6-hour predictions and those of the 72-hour predictions made using the different models described in the Method part is presented in Figure 8. and Figure 9, respectively. In each chart, gray lines represent the actual measurements and blue lines, the predicted values. Predictions are presented at 3-hour intervals.

Data for dam inflow were available for the period between 2008 and 2016. For each of the years, predictions were made for the snowmelt season, i.e. from March to May. Data from the period between 2008 and 2015 were used for learning, and those for 2016 were used to validate the results; the figure shows the results of validation. The meteorological data used for prediction were actual measurements; the levels of accuracy of each of the predictive

techniques were tested and compared on the assumption that the meteorological forecasts were carried out in full.

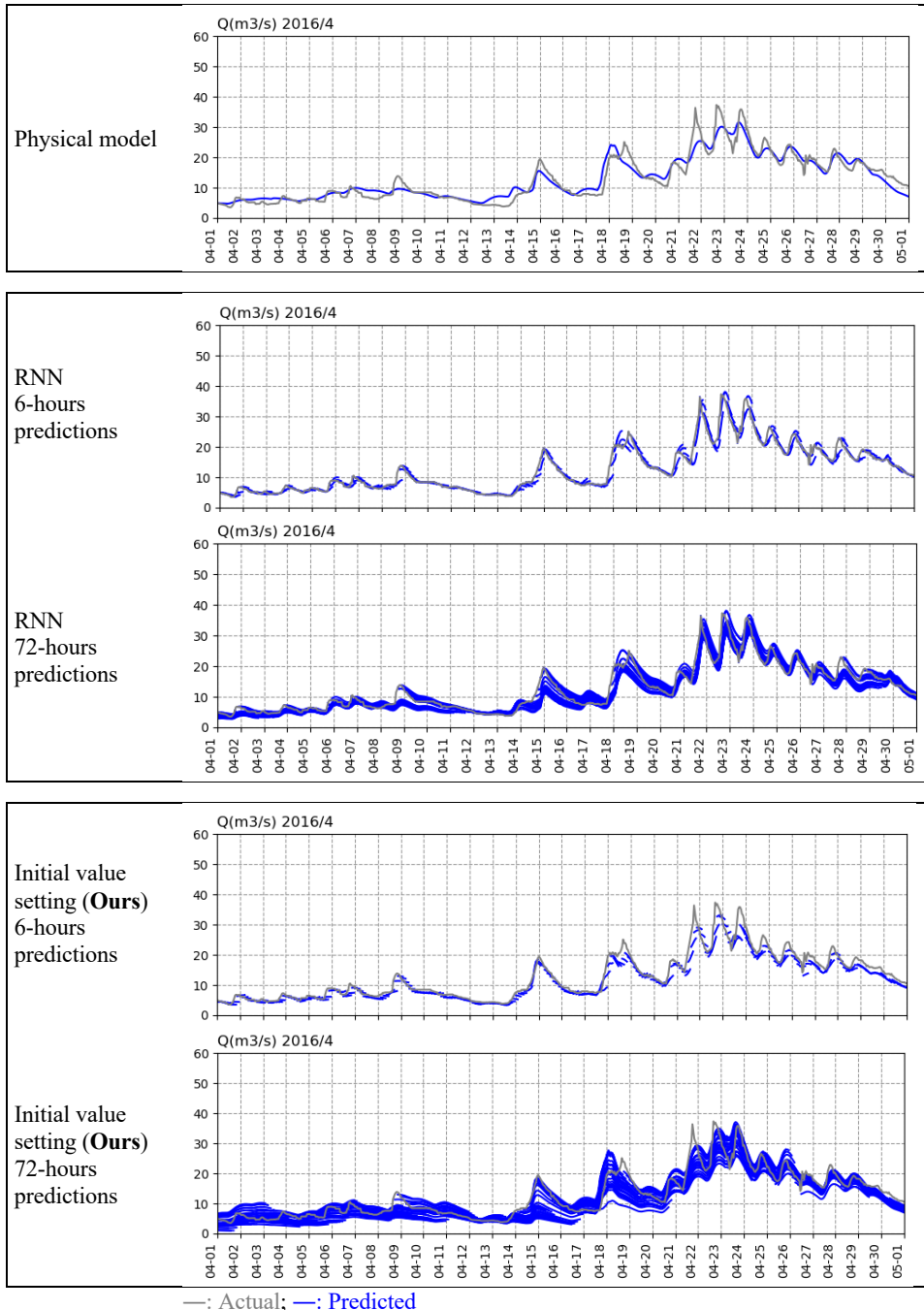

**Fig. 8.** Validation of dam inflow prediction models (April,2016).

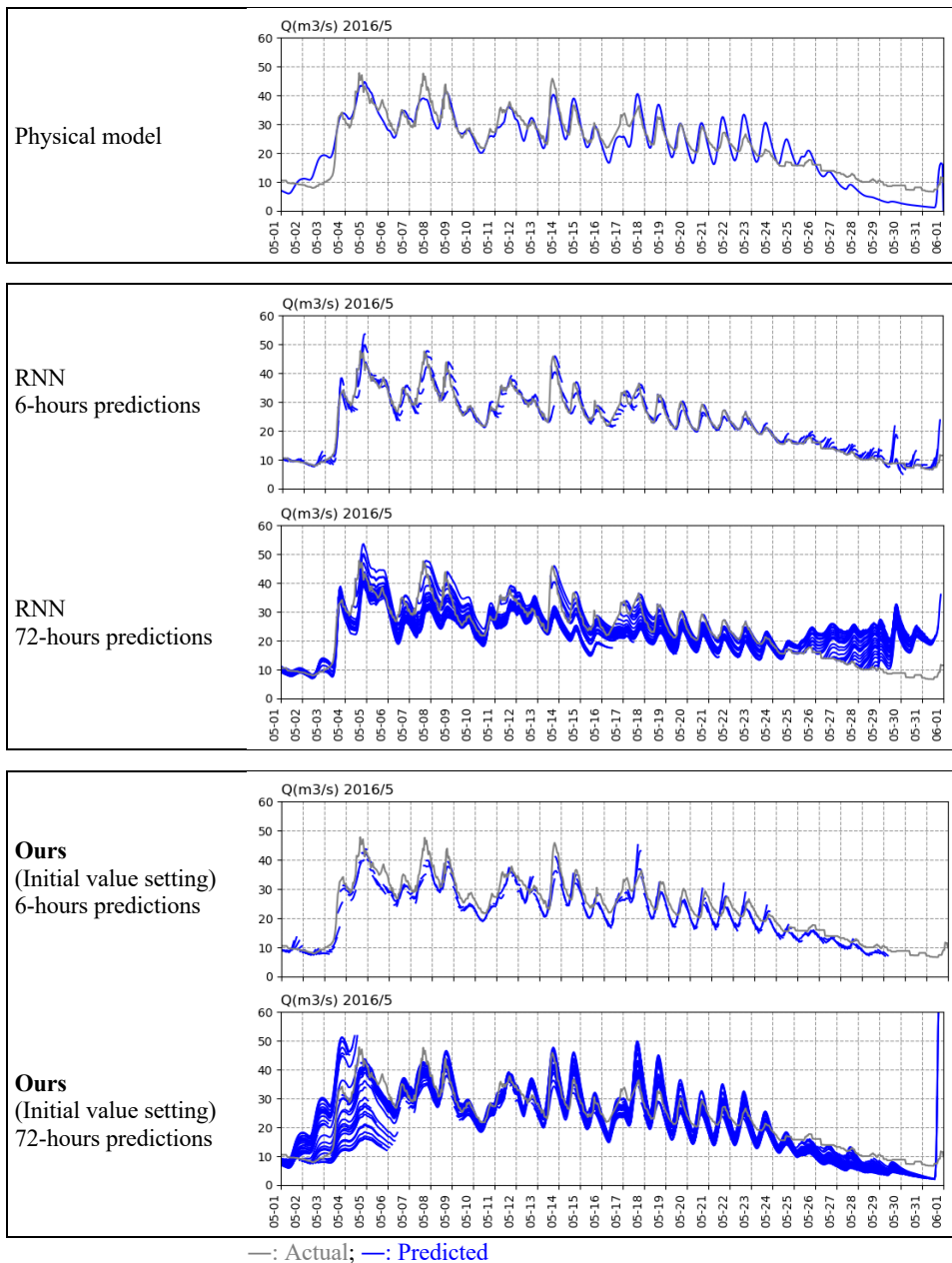

**Fig. 9.** Validation of dam inflow prediction models (May,2016).

### 3.3 Comparison of predictive accuracy of different dam inflow prediction models

The Root Mean Square Error (RMSE) and Nash coefficient of the results of validation of 6- and 72-hour predictions for 2016 made using the different models described in the Method part is presented in Table 2. In general, the smaller RMSW indicates a higher level of

predictive accuracy; and the closer to 1 the Nash coefficient is, the higher the level of accuracy is, with the Nash coefficient of 0.7 or greater denoting that the model is reproducible.

**Table 2.** Comparison of predictive accuracy of different dam inflow prediction models.

Model	RMSE			Nash Coefficient		
	—	6-hour predictions	72-hour predictions	—	6-hour predictions	72-hour predictions
Physical Model	1.8021			0.9442		
RNN		1.0564	2.4328		0.9696	0.8761
<b>Ours</b> (Initial value setting)		1.5361	2.4630		0.9479	0.8705

The results showed that the physical model retained relatively stable and high levels of accuracy even in the predictions. With the 6-hour predictions, meanwhile, the RNN models showed high levels of accuracy.

As the RNN model did not show very high levels of accuracy in the 72-hour predictions, it was demonstrated that physical models are more accurate in medium- to long-term predictions.

The model that estimated the initial values, in the meantime, produced predictions that were similar to those of the RNN model in the 72-hour predictions, but showed high levels of reproducibility in the 6-hour predictions.

As RNN models are mere autocorrelation models for prediction, they face difficulties in making medium- to long-term predictions. They are, on the other hand, capable of using actual measurements to make a direct prediction of values that should come next, and can often achieve high levels of accuracy in short-term predictions.

There was no clear advantage in the score, but in mid-May, for example, the model that estimated the initial values results appear to be more predictable than the RNN. It can be expected that more robust predictions will be possible than RNNs in unknown situations.

Physical models are capable of making predictions that take into account overall shifts in the dam inflow, but not without a period where the predictions are greatly different from the actual measurements.

As one of the techniques that link a physical model with AI, the use of AI to predict the initial values for a physical model made it possible for a physical model to make predictions based on values that were close to the actual measurements, as is the case with RNN models. This model achieved levels of accuracy that combine the strengths of both physical models and AI.

In the future, we will improve the model and aim for more robust long-term prediction. Prediction of weather conditions themselves and evaluation of uncertainty of prediction are also future issues.

## 4 Conclusions

This study clarified the problems of the conventional physical model (rainfall runoff model) and the prediction model by AI for the inflow of the dam during the snowmelt season in order to support efficient dam management.

Physical models behave in a manner that is bound by the laws of physics such as those for water balance and water movement. Therefore, predictions made based on such a model, for a scenario of future global warming for instance, are reliable to a certain degree. Making a prediction by freely incorporating actual measurements of the dam inflow, such as AI-based prediction, on the other hand, is not straightforward, and this requires the use of technologies such as data assimilation.

We built models existing physical model, RNN, and unique initial value setting model. Then, by constructing a semi-physical model that complements the problems of the physical model and the AI model, we developed a model as accurate as RNNs for predicting the inflow of snowmelt water during the snowmelt season compared to the single model.

There was no clear advantage in the score (RMSE and Nash coefficient), but in mid-May, for example, the model that estimated the initial values results appear to be more predictable than the RNN. It can be expected that more robust predictions will be possible than RNNs in unknown situations.

## References

1. T. Nishihara, M. Kazumata, *A Method to Forecast Dam Inflow in Snowmelt Season Using Meteorological and Hydrological Observation Data*, Civil Engineering Research Institute for Cold Region Monthly Report No.733 June 2014 (in Japanese) (2014)
2. J. Kondo, T. Yamazaki, *A prediction model for snow-melt, snow surface temperature and freezing depth using a heat balance method*. *J. Appl. Meteor.*, **29(5)**, 375-384 (in Japanese) (1990)
3. M. Nakatsugawa, K. Kudo, K. Hoshi, *Generalized Analysis of Runoff Due to Snowmelt Considering Storage of Accumulated Snow*, PROCEEDINGS OF HYDRAULIC ENGINEERING, **48** Pages 37-42 (in Japanese) (2004)
4. H. Baba, K. Hoshi, M. Fujita, *Development of Two-step Storage Routing Runoff Model Coupled with Evapotranspiration and Infiltration Model*, *J. Japan Soc. Hydrol. & Water Resour.* **14(5)**, (in Japanese) (2001)
5. S. Hochreiter, J. Schmidhuber, *Long Short-Term memory*, *Neural computation*, **9(8)**, 1735-1780 (1997)