

A renewable energy and hydrogen storage system for residential electricity supply

Simona Di Micco¹, Fabiana Romano^{1*}, Davide Lanni², Alessandra Perna², Viviana Cigolotti³, Maria Teresa Russo⁴, Claudio Miranda⁴ and Mariagiovanna Minutillo⁵

¹ Department of Engineering, University of Naples Parthenope, Napoli, Italy

² Department of Civil and Mechanical Engineering, University of Cassino and Southern Lazio, Cassino, Italy

³ ENEA - Italian National Agency for New Technologies, Energy and Sustainable Economic Development, Naples, Italy

⁴ GRADED spa

⁵ Department of Industrial Engineering, University of Salerno, Fisciano, Italy

Abstract. Because of the intermittent behavior of renewable sources, efficient, reliable and clean energy storage technologies are needed to achieve a more stable and secure energy supply. In this context, hydrogen technologies play a key role because they can store large amount of energy for long time. In this study, a hydrogen-based electrical energy storage system, integrated with a solar power plant, is designed and analyzed from the energy perspective. The system consists of a photovoltaic power plant, an alkaline electrolysis unit, metal hydride tanks for hydrogen storage, a Li-ion battery unit and a polymer electrolyte membrane fuel cell module. The system is conceived for supplying a residential user. A numerical model is developed for sizing the system's components and for evaluating their behaviors in terms of produced/stored electricity and hydrogen production. In this purpose, a sensitivity analysis varying PV plant size as well as the Li-ion battery capacity is performed for achieving the best compromise in terms of energy supply among all the considered power sources.

1 Introduction

Renewable technologies, developed almost worldwide in the last decade, play an essential role in electricity production due to several advantages compared to conventional fossil-based resources [1]. These are unlimited forms of energy, reliable and safe, without greenhouse gas emissions. However, the renewable power plants work in a discontinuous manner due to the intermittence of natural resources, causing an uncertain electricity supply [2]. In order to solve this problem, the integration of more stable and secure energy supply systems is needed. The most used method is based on the battery energy storage thanks to its high energy density and low investment costs. However, a promising alternative solution is based on the hydrogen technologies; as matter of fact, hydrogen has the potential to significantly improve the management and cost-effectiveness of micro grids based on Renewable Energy Sources (RES), particularly concerning the possibility to store larger quantities of renewable energy and for a longer time. Obviously, hydrogen based energy storage systems, are not intended to completely replace the traditional batteries, which remain the best option for short-term energy storage, but to complement it, offering at the same time also an option for long-term storage. Besides, from the economic perspective, the batteries are suitable for short term storage (i.e. 1 hour) but for the long term, the hydrogen storage is

* Corresponding author: fabiana.romano001@studenti.uniparthenope.it

more competitive. The water electrolysis assures the hydrogen production from renewable electricity. Currently, the Alkaline (AEL), the Proton Exchange Membrane (PEMEL) electrolyzers are the most available units on the market [3–6].

In this context, the aim of this paper is to investigate a hydrogen-based electrical energy storage system, integrated with a solar power plant, and to analyse its behavior in terms of electricity sharing and performances. The system proposes a promising technology to store hydrogen consisting of metal hydride tanks; metal hydride (MH) hydrogen storage provides the advantages of large volumetric capacity, safety, and long-term stability. In terms of safety, MHs allow to store hydrogen at low pressure (about 30 bar) that is a fundamental issue to be taken into account especially for residential user application. In addition, energy consumption for hydrogen compression is reduced because of the low pressure at which storage is required. This is a huge advantage from an economic point of view, as the lower energy consumption for H₂ compression can translate into lower operating expenses.

The hydrogen-based energy storage systems do not yet exist on commercial scale, but are basically still available as prototype solutions. Therefore, the optimization of components integration from a thermodynamic point of view (i.e., heat transfer) and the management of energy streams for satisfying the residential user requirements are issues that must be still investigated.

2 Methodology

The proposed study is devoted to assess the behavior of a renewable energy storage system based on hydrogen technologies (H₂RESTORE) integrated with a solar power plant for supplying an electrical residential user (i.e. single building complex). Figure 1 depicts the system layout.

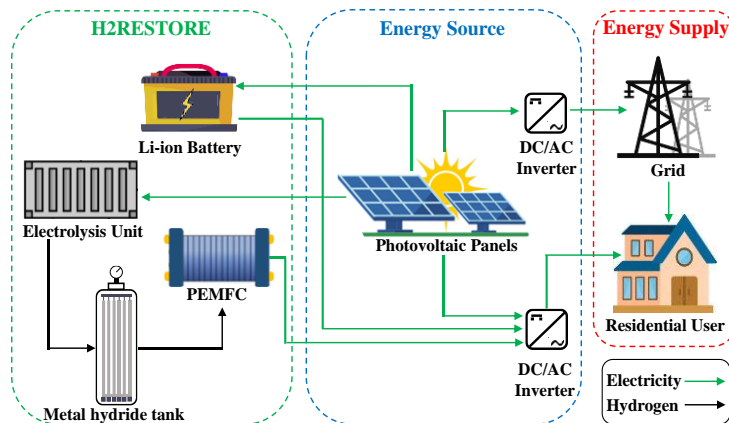

Fig. 1. Energy system schematic layout

The layout consists of the PV plant and the H₂RESTORE unit. The components integrated in the H₂RESTORE unit are: i) the electrolysis unit (AEL) for hydrogen production, ii) the metal hydride tanks for hydrogen storage, iii) the polymer electrolyte membrane fuel cell module (PEMFC), and iv) the Li-ion battery for electricity storage. The electricity demand of the residential user is directly satisfied by the PV plant and by the battery unit and the fuel cell unit according to a properly developed energy management strategy. This strategy has been developed with the aim of satisfying the electrical demand of the residential user by maximizing the utilization of the renewable source both directly (i.e. with PV plant) and

indirectly, by the H2RESTORE system. This means that the strategy is devoted, at the same time, to minimize the energy supplied/exported by/to the grid.

The grid connection allows to cover the electricity deficit and to export the electricity surplus. In this paper, in order to assess the optimal energy sharing in satisfying the electricity demand between the H2RESTORE unit, the PV plant and the grid, a numerical algorithm (developed in Matlab environment) based on the proposed energy management strategy has been implemented. The methodology of the developed numerical algorithm follows the flowchart illustrated in Figure 2.

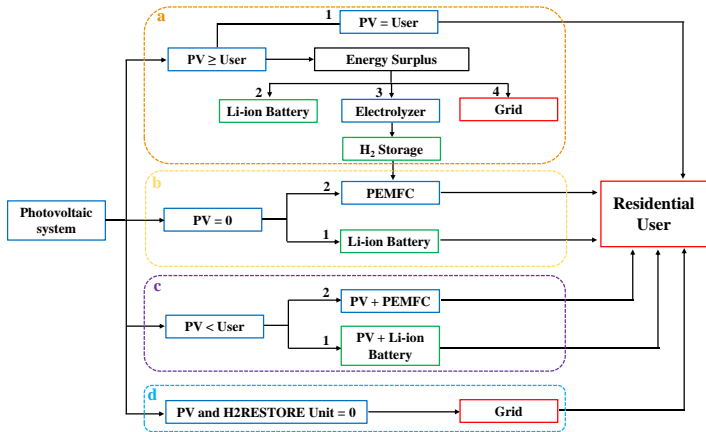

Fig. 2. Flowchart of the energy management strategy

It is noted that the start point of the flow chart is the power produced by the photovoltaic plant (PV plant); the management strategy is based on the following assumptions:

- if the PV power output is equal or higher than the user demand, it supplies the user and the electricity excess (when available) is used for recharging the Li-ion battery (2); if the battery unit is fully charged, the electricity surplus from the PV is used to supply the electrolysis unit (if the available electric power is in its operating range) for producing hydrogen (3); if the hydrogen storage tank is full, the electricity surplus is diverted to the grid (4).
- if the PV plant does not work, the user is supplied by the Li-ion battery (1) or by the PEMFC (2), according to the electrical or chemical stored energy availability.
- if the PV power output is lower than the residential user demand, the electricity deficit is covered by the Li-ion battery (1) (according to the battery discharge conditions), and, if necessary, by the PEMFC module fed by the stored hydrogen (2).
- if the PV plant and the H2RESTORE unit are not able to satisfy the user demand, its requirement is supplied from the electric grid.

2.1 Characterization and H2RESTORE description

The daily and the annual electrical demands of the residential user are illustrated in Figure 3 (10 kW is the maximum required power). The technical characteristics of the components and the main operating data of the H2RESTORE unit are summarized in Table 1.

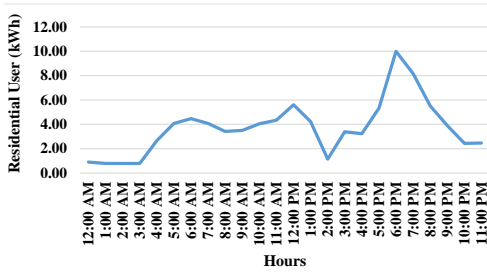

Fig. 3b. Daily electric demand

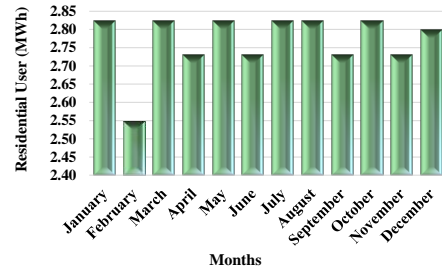

Fig. 3a. Annual electric demand

Table 1. H2RESTORE components size and operating parameters.

H2RESTORE components	Unit	Value
PEMFC	kW	5.6
PEMFC efficiency	%	48
Electrolysis Unit	kW	16
Electrolysis Unit Specific Consumption	kWh/kg	59
MH tank	kg	10
Li-ion Battery	kWh	60
Li-ion Battery Minimum Discharge	kWh	18
DC/AC efficiency	%	98

Concerning the PV plant, a 560 W (44.31V@12.63A) monocrystalline solar panel, with an efficiency of 20.5% at standard test conditions (STC), is selected as single module [7]. The global solar radiation incident on the PV array is calculated by using the HOMER Pro tool [8] by considering to install the plant in the South of Italy (Campania Region).

2.2 Sensitivity analysis

In order to characterize the behavior of the H2RESTORE unit integrated with the PV plant for satisfying the electricity demand of the selected residential user, the study has been carried out by considering different PV plant sizes and different battery unit capacities. Thus, a sensitivity analysis has been performed according to the two scenarios reported in Table 2.

Table 2. The sensitivity analysis: scenarios characterization

Scenario1			
PV plant size (kW _p)	Battery Capacity (kWh)		
30	60	30	20
Scenario2			
PV plant size (kW _p)	Battery Capacity (kWh)		
40	60	30	20

The sizes of the PV plant, used for this analysis, have been selected considering the annual energy production of the PV with respect to the annual energy demand of the residential user.

3 Results

By applying the developed numerical algorithm, based on the described energy management strategy, the distribution of the electric energy supplied by each power unit (PV plant, Battery unit, PEMFC module) and by the grid has been calculated. Figures 4 and 5 show the obtained results for both scenarios. By analyzing the results illustrated in Figure 4 (PV plant size 30 kW_p), it is possible to note that the electricity generated by the PEMFC module (fed by the stored hydrogen) and the electricity stored in the battery unit for all considered sizes (60 kWh, 30 kWh and 20 kWh), allow to cover the electricity deficit of the PV plant, with a contribution in the range 2%-17% and 11%-45%, respectively. The maximum annual energy contribution of the PEMFC module, about 13%, is obtained in the case of minimum battery capacity (20 kWh). However, by reducing the battery capacity from 60 kWh to 20 kWh, the annual percentage of electricity that must be drawn from the grid increases up to 34%. Thus, it is important to evaluate the best compromise between the size of the battery and the electricity from the grid. The electricity surplus from the PV plant, that is exported to the grid, is in the range of 2%-3%. Figure 5 shows the energy distribution calculated for Scenario 2. It is possible to ascertain that, by increasing the PV plant size (40 kW_p), the electricity drawn from the grid is in average lower. Moreover, with respect to the battery capacity, it follows that, by reducing it from 60 kWh to 20 kWh, the contribution of the electricity from the battery unit decreases up to 15%, and, consequently, the PEMFC module increases its electricity supplying (its contribution in satisfying the electric demand is in average about 22%). The electricity surplus from PV plant, that is exported to the grid, is about 14% by considering a battery unit with 40 kWh of capacity, and is in the range 1%-2% for lower battery capacities.

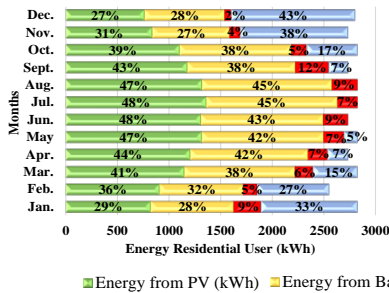

Months	Residential User	PV Production	From PV to User	From Battery to User	From PEMFC to User	From Grid to User	From PV to Battery	From PV to Electrolyzer	From PV to Grid
Jan.	2.82	2.05	0.83	0.80	0.26	0.93	0.76	0.43	0.04
Feb.	2.55	2.24	0.91	0.81	0.13	0.69	0.81	0.48	0.04
Mar.	2.82	3.04	1.15	1.07	0.18	0.43	1.07	0.76	0.05
Apr.	2.73	3.06	1.21	1.14	0.19	0.20	1.14	0.63	0.09
May	2.82	3.39	1.32	1.18	0.20	0.13	1.18	0.81	0.09
Jun.	2.73	3.40	1.31	1.18	0.24	0.00	1.18	0.82	0.10
Jul.	2.82	3.68	1.36	1.27	0.20	0.00	1.27	0.93	0.12
Aug.	2.82	3.64	1.32	1.26	0.25	0.00	1.25	0.97	0.10
Sept.	2.73	3.21	1.18	1.04	0.32	0.19	1.04	0.92	0.07
Oct.	2.82	2.74	1.10	1.08	0.15	0.49	1.08	0.50	0.05
Nov.	2.73	2.00	0.84	0.75	0.10	1.04	0.75	0.39	0.02
Dec.	2.80	1.81	0.77	0.78	0.07	1.19	0.77	0.25	0.03
Tot									
MWh/y	33.21	34.27	13.27	12.36	2.29	5.29	12.31	7.89	0.79

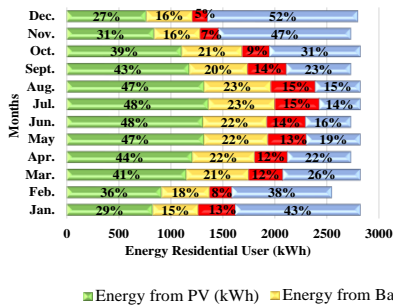

Months	Residential User	PV Production	From PV to User	From Battery to User	From PEMFC to User	From Grid to User	From PV to Battery	From PV to Electrolyzer	From PV to Grid
Jan.	2.82	2.05	0.83	0.44	0.36	1.20	0.42	0.77	0.04
Feb.	2.55	2.24	0.91	0.46	0.22	0.96	0.46	0.79	0.08
Mar.	2.82	3.04	1.15	0.60	0.33	0.75	0.60	1.22	0.07
Apr.	2.73	3.06	1.21	0.60	0.32	0.61	0.60	1.16	0.09
May	2.82	3.39	1.32	0.61	0.37	0.52	0.61	1.37	0.10
Jun.	2.73	3.40	1.31	0.61	0.37	0.44	0.61	1.38	0.11
Jul.	2.82	3.68	1.36	0.64	0.43	0.40	0.64	1.57	0.11
Aug.	2.82	3.64	1.32	0.64	0.43	0.44	0.64	1.59	0.10
Sept.	2.73	3.21	1.18	0.56	0.38	0.62	0.56	1.38	0.10
Oct.	2.82	2.74	1.10	0.58	0.26	0.88	0.58	0.96	0.09
Nov.	2.73	2.00	0.84	0.44	0.18	1.27	0.44	0.67	0.05
Dec.	2.80	1.81	0.77	0.44	0.15	1.44	0.44	0.55	0.05
Tot									
MWh/y	33.21	34.27	13.27	6.62	3.79	9.53	6.59	13.41	1.00

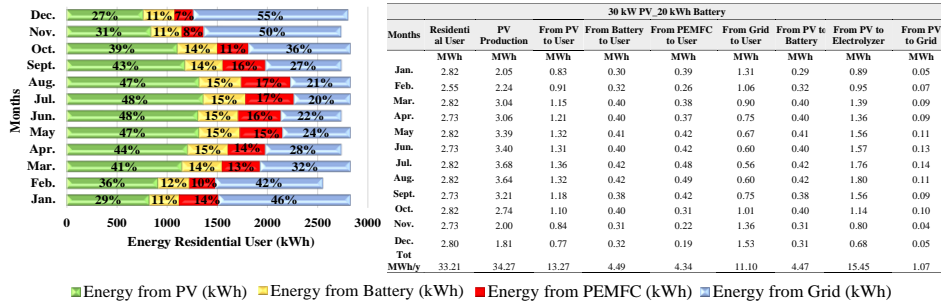

Fig. 4. Scenario 1: distribution of the electric energy production with respect to the energy demand

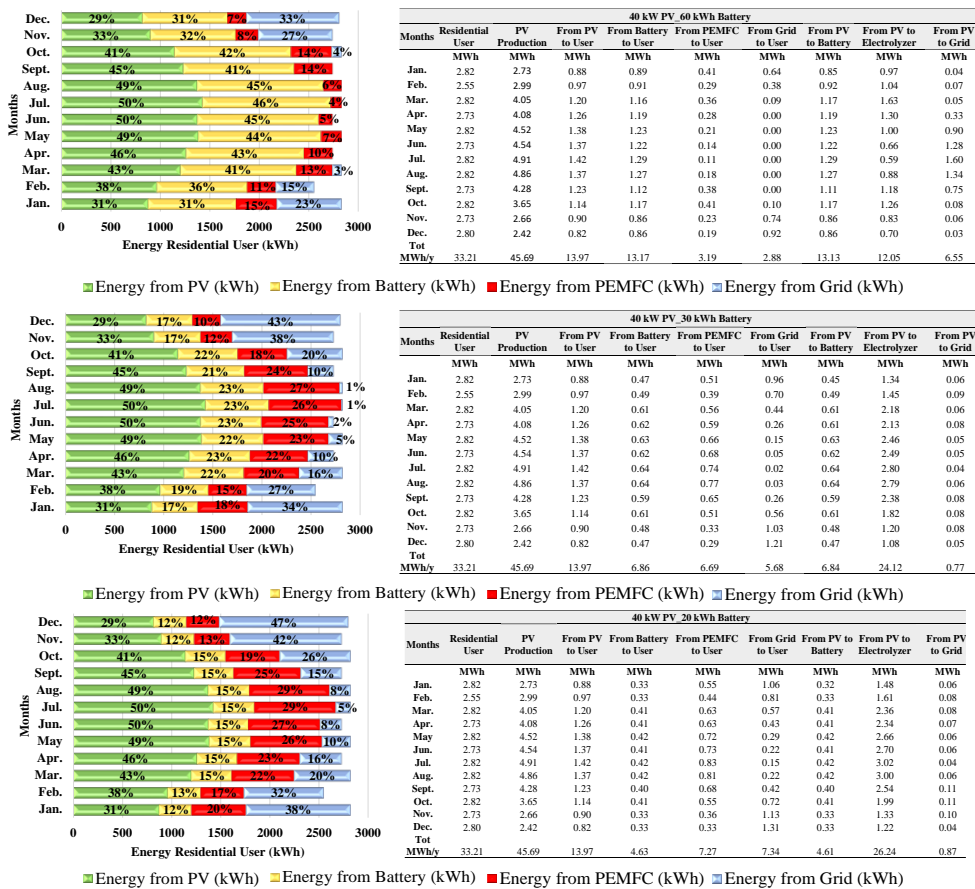

Fig. 5. Scenario 2: distribution of the electric energy production with respect to the energy demand

4 Conclusion

In this study, an electrical energy storage system (H2RESTORE), integrated with a PV power plant, is designed and analyzed from the perspective of energy supply. The analysis is performed by studying the behavior of H2RESTORE in storing the electricity produced by the PV plant and in satisfying the electricity demand of a residential user. By applying the energy management strategy implemented in the developed numerical algorithm, the distribution of the electric energy supplied by each power unit (PV plant, Battery unit, PEMFC module) and by the grid, is calculated. Results have highlighted that, according to the specific, it is important to evaluate, first of all the size of the PV plant, as well as to find the best compromise between the capacity of the battery unit and the electricity required from the grid. As matter of fact, the goal of the optimized management strategy has been to assure the electrical user satisfaction, exploiting all the H2RESTORE system by minimizing, at the same time, the electricity drawn from the grid. This study proposes a preliminary sensitivity analysis focused on the PV and Battery sizes. The results highlighted that the best compromise is based on the Scenario 2 (40 kW_p PV plant) with 30 kWh of battery unit; this scenario allows having an energy supply by the PEMFC module of about 20% and an integration from grid of about 17%, respectively. Further investigations on the sizes of the other components will be carried out in future studies.

Reference

1. P. Sokolnikova, P. Lombardi, B. Arendarski, K. Suslov, A. M. Pantaleo, M. Kranhold, and P. Komarnicki, *Renew. Energy* **155**, 979 (2020)
2. A. Toopshekan, H. Yousefi, and F. R. Astaraci, *Energy* **213**, (2020)
3. A. D. Korberg, S. Brynolf, M. Grahn, and I. R. Skov, *Renew. Sustain. Energy Rev.* **142**, (2021)
4. S. S. Hosseini Dehshiri, *Energy* **240**, 122814 (2022)
5. S. Ghandehariun and A. Kumar, *Int. J. Hydrogen Energy* **41**, 9696 (2016)
6. P. Fragiacomano and M. Genovese, *Energy Convers. Manag.* **223**, 113332 (2020)
7. A. Perna, E. Jannelli, S. Di Micco, F. Romano, and M. Minutillo, *Energy Convers. Manag.* **278**, 116702 (2023)
8. HOMER-ENERGY, HOMER Energy 416 (2016), <https://www.homerenergy.com/>